

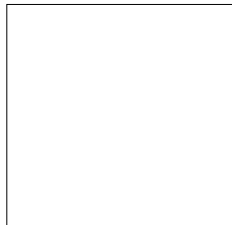

# *Legacy 36*

Dual Fuel Range



Users Guide  
&  
Installation Instructions

**This book contains many important safety messages.  
Always read and obey all safety messages.  
Installer: Leave these instructions with the appliance**

U104601-01

[www.aga-ranges.com](http://www.aga-ranges.com)

# WARNING

If the information in this manual is not followed exactly, a fire or explosion may result causing property damage, personal injury or death.

Do not **store or use gasoline or other flammable vapors and liquids in the vicinity of this or any other appliance.**

## WHAT TO DO IF YOU SMELL GAS

Do not **try to light any appliance.**

Do not **touch any electrical switch**

Do not **use any phone in your building.**

Immediately **call your gas supplier from a neighbor's phone. Follow the gas supplier's instructions.**

If you cannot reach your gas supplier, call the fire department.

**Installation and service must be performed by a qualified installer, service agency or the gas supplier.**

# Warning

The anti-tip device supplied with this range must be correctly fitted when the appliance is installed. This will reduce risk of tipping of the appliance from abnormal usage or by excessive loading of the oven door

	<p><b>⚠ WARNING</b></p> <ul style="list-style-type: none"><li>• ALL RANGES CAN TIP</li><li>• INJURY TO PERSONS COULD RESULT</li><li>• INSTALL ANTI-TIP BRACKET PACKED WITH RANGE</li><li>• SEE INSTALLATION INSTRUCTIONS</li></ul>
---	--

## Using your Range

General Safety Instructions	Page 8
Cooktop Burners	Page 10
The Broiler	Page 11
The Ovens	Page 12
The Left Hand Multi-function Oven	Page 12
The Right Hand Tall Oven	Page 12
The Clock	Page 13
Both ovens	Page 16
Multi-function oven	Page 16
Handyrack	Page 18
Main Oven racks	Page 18
Tall oven racks	Page 19
Oven light	Page 19
Multi-function Oven cooking guide	Page 20
Cooking chart	Page 21
Cleaning your range	Page 22
Troubleshooting	Page 24
Service and spares	Page 26
Installation	Page 29

Read all instructions before using this appliance.

## Important Safety Information

Save these instructions for future reference.

### WARNING

Have your appliance properly installed and grounded by a qualified technician in accordance with the National Electrical Code ANSI/NFPA No. 70—latest edition, and local code requirements. In Canada, electrical grounding must be in accordance with the current CSA C22.1 Canadian Electrical Code Part 1 and/or local codes.

Install only as described in the installation section of this book.

Ask your dealer to recommend a qualified technician and an authorized repair service. Know how to disconnect the power to the range at the circuit breaker or fuse box in case of an emergency

### WARNING

The anti-tip device supplied with this range must be correctly fitted when the appliance is installed. This will reduce risk of tipping of the appliance from abnormal usage or by excessive loading of the oven door



### WARNING

- ALL RANGES CAN TIP
- INJURY TO PERSONS COULD RESULT
- INSTALL ANTI-TIP BRACKET PACKED WITH RANGE
- SEE INSTALLATION INSTRUCTIONS

### WARNING

#### In Case of Fire

Do not use water on grease fires. Never pick up a flaming pan. Turn the controls off. Smother a flaming pan on a cooktop burner by covering the pan completely with a well fitting lid or baking tray. If available use a multipurpose dry chemical or foam-type fire extinguisher.

If fire is in the oven or broiler pan, smother by closing oven door. Open doors and windows or if a hood is fitted turn it on to remove smoke and odor.

#### To Prevent Fire or Smoke Damage

Before using the range make sure all the packing materials have been removed.

Always keep the area around the range free from combustible materials, gasoline, and other flammable vapors and liquids.

If the range is installed near a window, proper precautions should be taken to prevent curtains from blowing over the burners.

#### NEVER leave any items on the range

**cooktop. The hot air from the oven or broiler vent may ignite flammable items and may increase pressure in closed containers, which may cause them to burst. Many aerosol-type spray cans are EXPLOSIVE when exposed to heat and may be highly flammable. Avoid their use or storage near an appliance.**

Many plastics will burn and most are damaged by heat. Keep plastic items away from parts of the range that may become warm or hot. Do not leave plastic items on the cooktop as they may burn, melt or soften if left too close to a vent or a lighted burner.

Read all instructions before using this appliance.

## Important Safety Information

Save these instructions for future reference.

Storage should not be fitted directly above a range. If anything is stored above the range, it should be limited to infrequently used items which can be safely stored in an area subjected to heat from a range. Temperatures may be unsafe for some items, such as volatile liquids, cleaners or aerosol sprays.

Destroy the carton and plastic bags after unpacking the range. Never allow children to play with packaging material.

### CAUTION

For safety considerations never use your range to heat the room.

### WARNING

User servicing—Do not repair or replace any part of the appliance unless specifically recommended in this User Manual.

All other servicing should be done only by a qualified technician, this may reduce the risk of personal injury and damage to the range.

Never modify or alter the construction of a range by removing leveling legs, panels, wire covers, anti-tip brackets/screws, or any other part of the product.

### WARNING

To avoid personal injury, do not sit, stand or lean on oven or grill doors or drawer.

Leaning, sitting or stepping on the doors or drawer of this range can result in serious injuries and also cause damage to the range. Do not allow anyone to climb, stand or hang on any part of the range.

### WARNING

#### Do Not Leave Children Alone

Babies, toddlers and young children should not be allowed near the range at any time. They should never be allowed to sit or stand on any part of the appliance.

Do not allow children to climb or play around the range. The weight of a child on an open door may cause the range to tip, resulting in serious burns or other injury.

Teach them not to play with controls or any other part of the range.

Never store items of interest to children in the cabinets above a range or on backguard of a range; children climbing on the range to reach them could be seriously injured.

Never use your appliance to heat the room.

### WARNING

#### Do not use the oven for storage.

This instruction is based on safety considerations

Flammable materials should not be stored in an oven, the grill chamber, the range storage drawer or near the cooktop burners. This includes paper, plastic and cloth items, such as cookbooks, plasticware and towels, as well as flammable liquids. Do not store explosives, such as aerosol cans, on or near the appliance.

Flammable materials may explode and result in fire or property damage.

Read all instructions before using this appliance.

## Important Safety Information

Save these instructions for future reference.

### WARNING

To avoid risk of electrical shock, personal injury, or death, make sure your range has been properly grounded and always disconnect it from main power supply before servicing.

### CAUTION

#### Do not touch cook top burners or areas near burners

Gas burners may be hot even if they have been off for some time. Areas near the gas burners may become hot enough to cause burns. During and after use, do not touch, or let clothing touch or other flammable materials contact the burners or areas near the burners until they have had enough time to cool. These areas include the rangetop and backguard.

### CAUTION

#### DO NOT TOUCH HEATING ELEMENTS OR INTERIOR SURFACES OF OVENS

Oven and Broiler heating elements may be hot though they are dark in color. Interior surfaces of an oven or broiler may become hot enough to cause burns. During and after use, do not touch, or let clothing or other flammable materials touch heating elements or interior surfaces of oven until they have had enough time to cool.

Other range surfaces that may become hot enough to cause burns are the oven door and oven vent at the base of the range splashback.

#### Wear Suitable Clothing

Never wear loose-fitting or hanging clothes while using the range. Be careful when reaching for items stored in cabinets over the cooktop. Flammable material could be ignited if brought in contact with a burner flame or hot surface and may cause severe burns.

#### Use Only Dry Potholders or Oven Gloves

Moist or damp potholders on hot surfaces may result in burns from steam. Never let a potholder touch hot heating elements.

Do not use a towel or other bulky cloth in place of a glove. They might catch fire if they touch a hot surface.

Use dry oven gloves when applicable - using damp gloves might result in steam burns when you touch a hot surface. Never operate the range with wet hands.

### CAUTION

#### Important Safety Notice and Warning

The California Safe Drinking Water and Toxic Enforcement Act of 1986 (Proposition 65) requires the Governor of California to publish a list of substances known to the State of California to cause cancer or reproductive harm, and requires businesses to warn customers of potential exposures to such substances.

This appliance contains or produces a chemical or chemicals which can cause death or serious illness and which are known to the state of California to cause cancer, birth defects or other reproductive harm.

Users of this appliance are hereby warned that the burning of gas can result in low-level exposure to some of the listed substances, including benzene, formaldehyde and soot, due primarily to the incomplete combustion of natural gas or liquid petroleum (LP) fuels. Properly adjusted burners will minimize incomplete combustion. Exposure to these substances can also be minimized by properly venting the burners to the outdoors.

Read all instructions before using this appliance.

## Important Safety Information

Save these instructions for future reference.

To reduce the risk from substances in the fuel or from fuel combustion make sure this appliance is installed, operated, and maintained according to the instructions in this booklet.

**Important: Never keep pet birds in the kitchen or in rooms where the fumes from the kitchen could reach. Birds have a very sensitive respiratory system. Fumes released due to overheated cooking oil, fat, margarine and overheated non-stick cookware may be harmful.**

**Important - Save the installation instructions for the local electrical inspector's use.**

### Proper Installation

Be sure your appliance is properly installed and grounded by a qualified technician.



### User Servicing

Do not repair or replace any part of the appliance unless specifically recommended in the manual. All other servicing should be referred to a qualified technician.

### Cooktop burners

#### Quality of Flames

On Natural Gas the burners' flames should be a blueish color with, at most, a slight yellowish fringe.

On Propane gas the flames may be "softer". The cooktop burner flames may have a slight yellowish tip.

If the flame burns with a long white tip you should call for service.

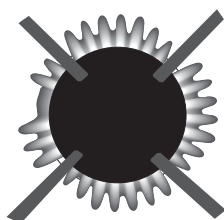

*Normal flame appearance*

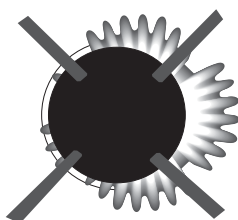

*Burner not fitted correctly*

**MAKE SURE THE FLOW OF COMBUSTION AND VENTILATION AIR TO THE RANGE IS UNOBSTRUCTED.**

#### Use the Right Size Pan

This appliance is equipped with burners of different sizes. Use utensils with flat bottoms. Do not use unstable pans and position the handles away from the edge of the cooktop. Make sure the flames are under the pans. It's not safe to let the flames burn up the sides of the pan; the handle may get too hot.

Proper relationship of utensil to burner will also improve efficiency.

**Never Leave Cooktop burners unattended at high settings. Pans boiling over can cause smoking and greasy spills may catch on fire.**

**Protective Liners - Do not use aluminum foil to line cooktop bowls or oven bottoms. Foil liners may result in a risk of electric shock, or fire and will damage the enamel finish.**

**Glazed Cooking Utensils - Only certain types of glass, glass/ceramic, ceramic, earthenware, or other glazed utensils are suitable for range-top use without breaking due to the sudden change in temperature.**

Read all instructions before using this appliance.

## Important Safety Information

Save these instructions for future reference.

Utensil handles **should be turned inward and not over adjacent burners. If handles are left over adjacent burners they will get hot and may burn.**

### Ovens

Use Care **When Opening Door**

**Let hot air and steam escape before removing or replacing food.**

Never **heat unopened food containers.**

**Pressure build up may make container burst and cause injury.**

Keep **oven vent ducts unobstructed.**

### Placement of Oven Racks

Always place oven racks in desired location while oven is cool. If rack must be moved while oven is hot, do not let potholder contact hot heating element in oven.

### CAUTION

Do not store items of interest to children in cabinets above a range or on the backguard of a range - children climbing on the range to reach items could be seriously injured.

### WARNING

THIS APPLIANCE IS PROVIDED WITH ROLLERS TO FACILITATE MOVEMENT DURING INSTALLATION. THE RANGE SHOULD NOT BE MOVED AFTER INSTALLATION.

## General Safety Instructions

This appliance must be installed by a competent person in accordance with the installation instructions. The installation must comply with the relevant regulations and also the local electricity supply company requirements

This appliance is designed for domestic cooking only. Use for any other purpose could invalidate any warranty or liability claim.

The use of a gas cooking appliance results in the production of heat and moisture in the room in which it is installed. Ensure that the kitchen is well ventilated: keep natural ventilation holes open or install a mechanical ventilation device, (mechanical extractor hood).

Prolonged intensive use of the appliance may call for additional ventilation, for example opening a window, or more effective ventilation, for example increasing the level of mechanical ventilation where present.

The range should be serviced by a qualified service engineer and only approved spare parts used. Have the installer show you the location of the range control switch. Mark it for easy reference. Always allow the range to cool and then switch off at the mains before cleaning or carrying out any maintenance work, unless specified otherwise in this guide.

All parts of the range become hot with use and will retain heat even after you have stopped cooking.

Take care when touching range, to minimize the possibility of burns, always be certain that the controls are in the OFF position and that it is cool before attempting to clean the range.

Clean with caution. If a wet sponge or cloth is used to wipe spills on a hot surface, be careful to avoid steam burns. Some cleansers can produce noxious fumes if applied to a hot surface.

Read all instructions before using this appliance.

## Important Safety Information

**Save these instructions for future reference.**

Clean only parts listed in this guide.

In the interests of hygiene and safety the range should be kept clean at all times as a build up in fats and other food stuff could result in a fire.

Always keep combustible wall coverings or curtains etc. a safe distance away from your range.

Do not spray aerosols in the vicinity of the range while it is in use.

Do not store or use combustible materials, or flammable liquids in the vicinity of this appliance.

Take great care when heating fats and oils, as they will ignite if they get too hot.

Use a deep fat thermometer whenever possible to prevent overheating fat beyond the smoking point.

Never leave a deep fry pan unattended. Always heat fat slowly, and watch as it heats. Deep fry pans should be only one third full of fat. Filling the pan too full of fat can cause spill over when food is added. If you use a combination of oils or fats in frying, stir them together before heating, or as the fats melt.

Foods for frying should be as dry as possible. Frost on frozen foods or moisture on fresh foods can cause hot fat to bubble up and over the sides of the pan. Carefully watch for spills or overheating of foods when frying at high or medium high temperatures. Never try to move a pan of hot fat, especially a deep fry pan. Wait until the fat is cool.

When the broiler is on, do not use the top of the flue (the slot along the back of the range) for warming plates, dishes, drying dish towels or softening butter.

When using an electrical appliance near the cooktop, be sure that the cord of the appliance does not come into contact with the cooktop.

Take care that no water seeps into the appliance

Make sure that your kitchen is well ventilated at all times. Use extractor fans or hoods when fitted.

The range is designed for cooking foods only and must not be used for any other purpose.

The oven should NOT be used for heating the kitchen, not only does this waste fuel but the control knobs may become overheated.

When the oven is on DO NOT leave the oven door open for longer than necessary.

The specification of this range should not be altered.

This appliance is heavy, take care when moving it.

When the range is not in use ensure that the control knobs are in the off position.

## Using your Range

### Cooktop Burners

The drawing by each knob indicates which burner that knob controls. Each burner has a special safety device that stops the flow of gas if the flame goes out.

Push in and turn a knob to the (⚡HI) lighting position.

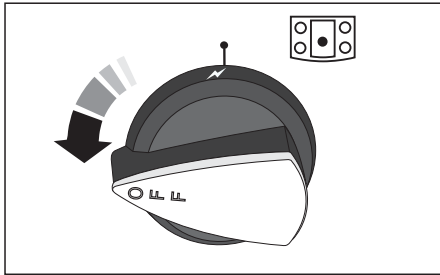

Keep holding the knob pressed in to let the gas through for few seconds. The igniter should spark and light the gas.

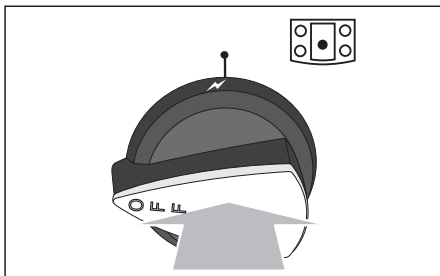

If, when you let go of the control knob, the burner goes out, the safety device has not held in. Turn the control to the off position and wait one minute, then try again this time holding in the control knob for slightly longer.

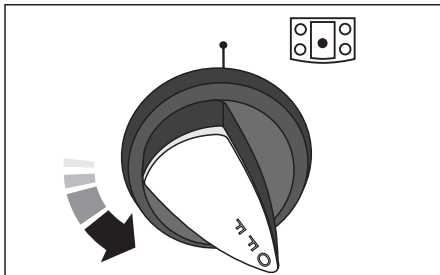

Adjust the flame height to suit by turning the knob. On this range the low position is beyond high, **not** between high and off. The 'LO' marks the low position. Turn the knob towards it after the contents of a pan have boiled.

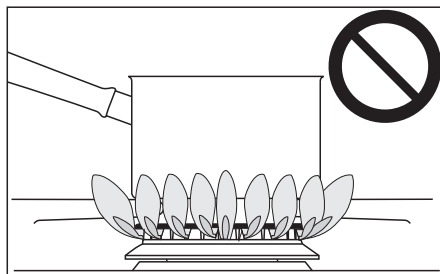

Make sure flames are under the pans. For safety reasons, adjust the flames so that they do not extend beyond the edge of the cooking utensil. This instruction is based on safety considerations.

Pans and kettles with concave bases or down turned base rims should not be used.

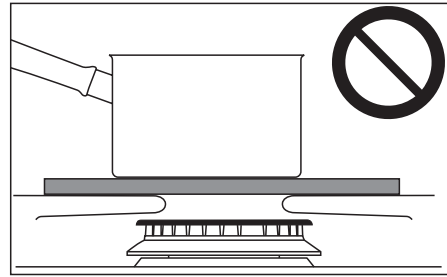

Simmering aids, such as asbestos or mesh mats, are **NOT** recommended. They will reduce burner performance and could damage the grates.

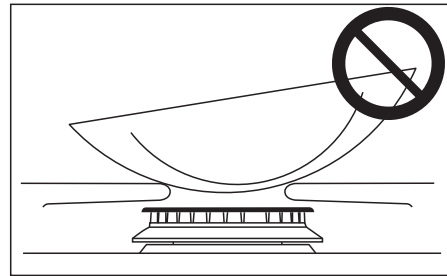

Avoid using unstable and misshapen pans that may tilt easily and pans with a very small base diameter e.g. milk pans, single egg poachers. The minimum pan diameter recommended is 4<sup>3</sup>/<sub>4</sub>".

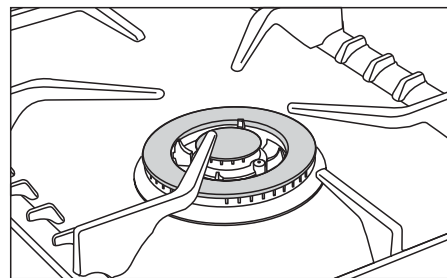

The Wok burner is designed to provide even heat over a large area. It is ideal for large pans and stir frying. When using large pans ensure that the pan does not over hang the edge of the cooktop. For heating smaller pans the smaller burners may be more efficient.

**When a cooktop burner knob is pressed in, sparks will be made at every burner, this is normal.**

If after lighting, a cooktop burner's flame goes out, turn it off and leave it for one minute before relighting it.

#### Igniting Cooktop Burners without Electricity

If there is a power failure, the cooktop burners can be lit with a match.

1. Hold a burning a match ½ inch from the burner head keeping your hand as far horizontally away from the burner as possible.
2. Push and turn burner control knob to HI/ lighting position. As soon as the burner flame lights move your hand away. With your other hand, keep holding the knob pressed for a few seconds so that the burner safety device can 'sense' the heat of the flame.

## Using your Range

3. Turn burner control knob to OFF position when finished.

You can remove the burner cap and head for cleaning, see page 24.

You should wipe the enamel top surface of the range around the cooktop burners as soon as possible after spills occur.

### Note:

Use of aluminum pans may cause metallic marking of the grates. This does not affect the durability of the enamel and may be cleaned off with a metal polish.

## The Broiler

**CAUTION: Accessible parts may be hot when the broiler is in use. Young children should be kept away.**

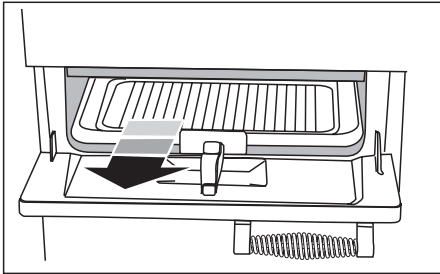

Remove the pan from the bottom of the broiler compartment.

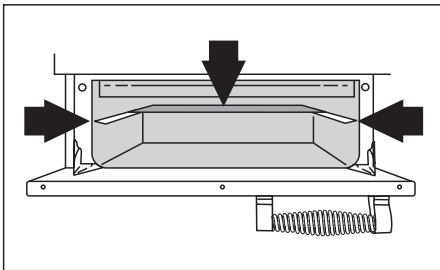

After placing your food on the broiler pan grid, slide the broiler pan onto the side supports just below the elements. Make sure it is pushed right in and touches the backstop.

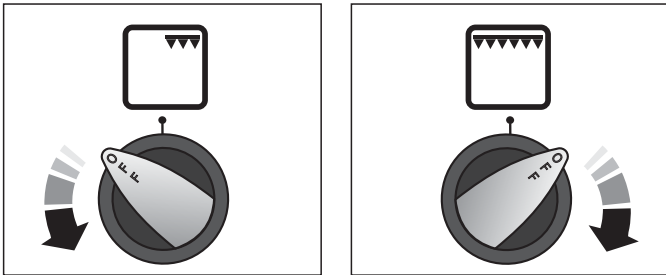

The broiler has two elements that allow either the whole area of the pan to be heated or just the right hand half.

Turn the knob to position 3.

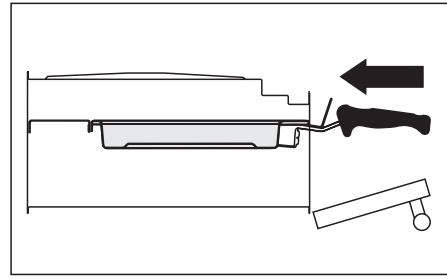

For best results preheat for 2 minutes with the broiler pan in position. After placing your food on the broiler pan grid, slide the broiler pan onto the side supports. Adjust the heat to suit by turning the knob.

**Make sure it is pushed right in and touches the back stop.**

**Never close the broiler door when the broiler is on.**

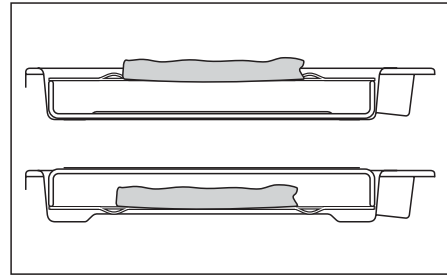

The broiler pan grid can be turned over to give two cooking positions.



Don't leave the broiler on for more than a few moments, without the broiler pan underneath it.

*For best results, especially with toast, preheat the broiler with the broiler pan in the cooking position for two minutes before use.*

The broiler grid can be removed and the food placed on it while you are waiting for the broiler to preheat.

*The broiler pan grid can be turned over to give two cooking positions.*

You can brown the top of dishes cooked in the oven, under the broiler by placing the dish onto the base of the broiler pan, which can easily slide along the floor of the broiler cavity.

# Using your Range

## The Ovens

During use the appliance becomes hot. Care should be taken to avoid touching the heating elements inside the oven.

The clock must be set to the time of day before the ovens will work. See 'The Clock' section for instructions on setting the time of day.

### The Left Hand Multi-function Oven

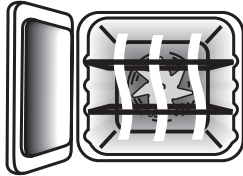

The left hand oven is a Multi-function oven. As well as the oven fan and fan element, it is fitted with two extra heating elements, one visible in the top of the oven and the second under the oven base. Take care to avoid touching the top element and element deflector when placing or removing items from the oven. For more detail on this oven see the section 'Multi-function oven'.

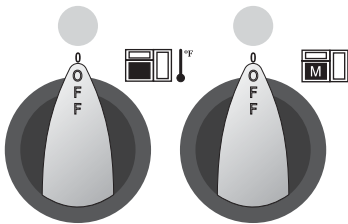

*function      temperature*

The Multi-function oven has two controls, a function selector and a temperature setting knob.

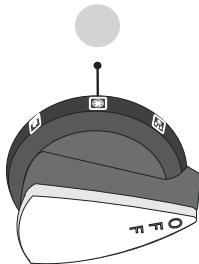

Turn the function selector control to a cooking function. This is the fan oven setting.

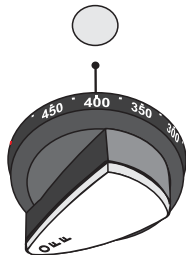

Turn the oven temperature knob to the temperature you need.

The oven heating light will glow until the oven has reached the temperature you selected. It will then cycle on and off during cooking.

### The Right Hand Tall Oven

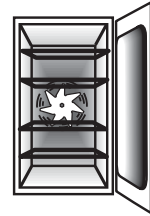

The fan in the right hand Tall oven circulates hot air continuously, which means faster more even cooking. The recommended cooking temperatures for a fanned oven are generally lower than a non-fanned oven.

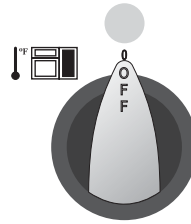

The right hand fan oven control is at the right hand end of the control panel.

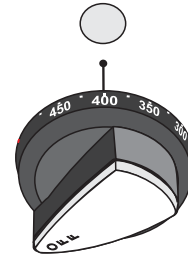

Turn the oven temperature knob to the temperature you need.

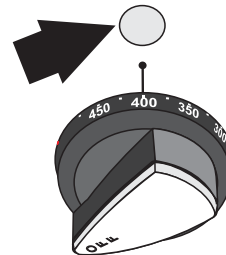

The oven heating light will glow until the oven has reached the temperature you selected. It will then cycle on and off during cooking.

## Using your Range

### The Clock

#### Setting the time of day

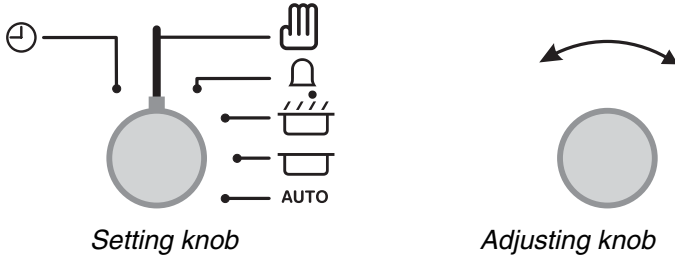

When the clock is first connected the display will flash ( ) and ( ) alternately.

<p>To set the clock to read the time of day turn and hold the Setting knob to the clock symbol (⌚).</p>	
---	--

<p>At the same time turn the Adjusting knob left or right until the clock shows the time of day. .</p>	
--	--

Let go of the Setting knob and it will spring back to the vertical ( ) oven manual setting.

If the key symbol ( ) appears on the left of the display you have accidentally turned on the key lock feature. See the section 'Clock Special Features'.

#### To time something that's cooking (minute minder)

Turn the Setting knob to the right to the ( ) minute minder setting - it should click into position. Use the adjustment knob to set the time you need.

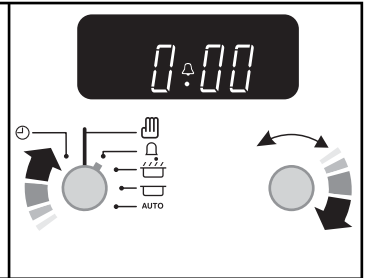

You can turn the knob back to the ( ) manual setting to keep an eye on the time of day or leave it in the ( ) minute minder position as the time ticks down.

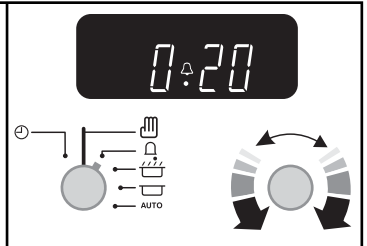

#### To stop the beeper when it sounds

Turn the Adjusting knob counter clockwise

#### To stop automatically

Use when you have started the oven manually.

Turn the Setting knob to the ( ) position. Use the adjustment knob to set the time you need.

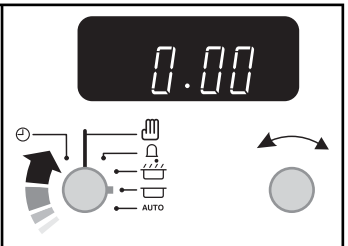

'Stop Time' shows. AUTO will show in the display.

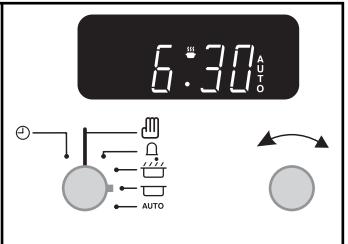

Turn the Setting knob to the ( ) setting.

When your cooking is finished the beeper sounds. Turn the Setting knob to the vertical ( ) to return to manual cooking.

## Using your Range

### To start and stop the oven automatically (delayed baking)

Before you set the clock, you must have two numbers clearly in mind.

The 'cook time', which is the period of time you want the oven to cook. The maximum cooking time is 11 hours 59 minutes.

The 'stop time', which is the time of day you want the oven to stop cooking. This must be less than 12 hours from the current time.

You cannot set a start time directly - this is set automatically by setting the cooking period and stop time.

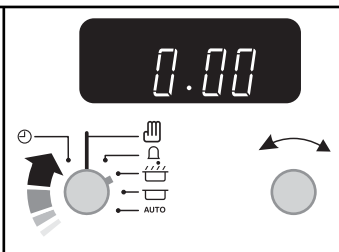
<p>Turn the Setting knob to the (🔒) position. Use the Adjusting knob to set the 'cooking time' you need.</p>	
--	---

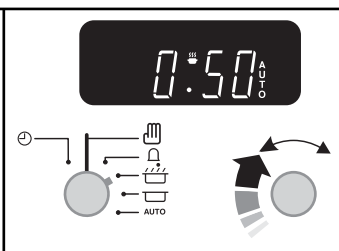
<p>Turn the Setting knob to the (🕒) position. The display will show the current time of day plus the 'cook period' you just set.</p>	
--	--

Use the adjustment knob to set the 'Stop time' you need.

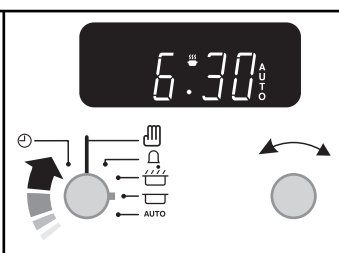
<p>'Stop Time' shows. AUTO will show in the display.</p>	
--	---

Set the oven(s) to the cooking temperature you need (don't forget to set a function if using the Multi-function oven).

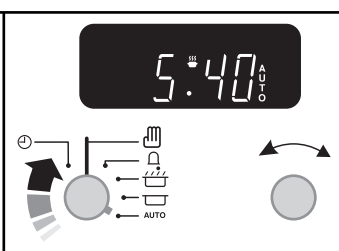
<p>Turn the Setting knob to the (AUTO) setting. The clock shows the time of day and 'AUTO'.</p>	
---	---

When your cooking is finished the beeper sounds. Turn the Setting knob to the vertical (🔒) to return to manual cooking.

If you are out, don't worry about the beeper going off, it stops after a while. When you return, turn the Setting knob to the vertical (🔒) to return to manual cooking. Turn the thermostat to the off position.

### AUTO is showing, you want to reset to manual cooking.

You can cancel any automatic settings by briefly turning the Setting knob to the manual symbol (🔒).

## Clock Special Features

### Key Lock

When the key lock is activated, the clock can be operated as usual but the ovens are locked and will not come on. This means that your child could select a cook program but the program will not be activated and ovens will not switch on.

### To activate the key lock

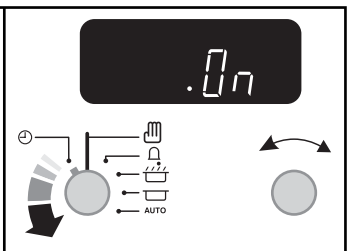
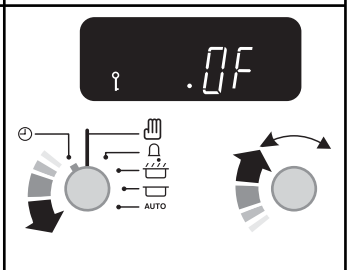
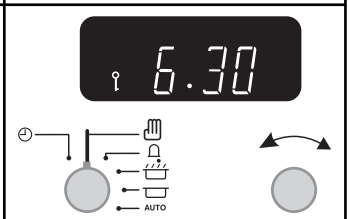
<p>Turn and hold the Setting knob to the clock symbol (🕒) for about 8 seconds. 'On' will appear on the display.</p>	
<p>Keep holding the Setting knob turned to the clock symbol (🕒) and turn the Adjusting knob clockwise until the key symbol (🔑) and 'Of' shows on the display. Let go of the knobs.</p>	
<p>The ovens are now locked. After a few seconds the display will revert to show the time of day and the key symbol.</p>	

## Using your Range

### To turn off the key lock

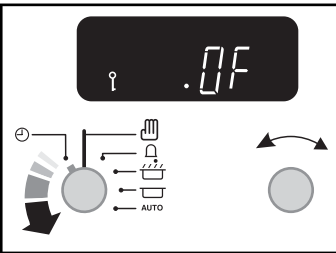
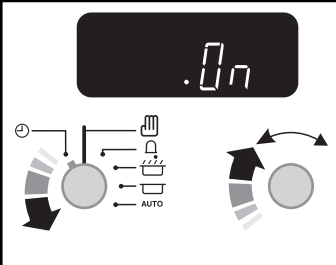
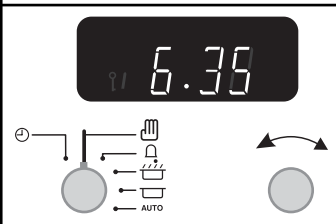
<p>Turn and hold the Setting knob to the clock symbol (⌚) for about 8 seconds. 'Of' will appear on the display.</p>	
<p>Keep holding the Setting knob turned to the clock symbol (⌚) and turn the Adjusting knob clockwise until the key symbol (Ⓚ) goes out on the display. Let go of the knobs.</p>	
<p>After a few seconds the display will revert to show the time of day.</p>	

The ovens can now be used normally.

### Cooking using the timer (Delayed baking)

The timer can be used to turn just one oven or both on and off automatically. The start and stop time must be the same for both ovens but different cooking temperatures can be set.

*If you want to turn one of the ovens on at the same time as the timer is set for automatic cooking, you must wait until the timer has turned on the oven/ ovens first. Then you can adjust either of them manually in the normal way.*

You can set the oven for a combined delay and cook cycle of up to 11 hours 59 minutes.

*If you want to cook more than one dish, choose dishes that require approximately the same time. However, dishes can be 'slowed down' slightly by using small containers and covering them with aluminum foil, or 'speeded up' slightly by cooking smaller quantities or placing in larger containers.*

Very perishable foods such as pork, dairy products or seafood should be avoided if a long delay period is planned, especially in hot weather.

*Don't place warm food in the oven.*

*Don't use an oven already warm.*

*Don't use if an adjoining oven is warm.*

Avoid using wine or beer if there is a delay period, as fermentation may take place.

*To avoid curdling, cream should be added to dishes just before serving.*

Fresh vegetables, which may discolor during a delay period, should be coated in melted fat or immersed in a water and lemon juice solution.

Fruit pies, custard tarts or similar wet mixtures on top of uncooked pastry are only satisfactory if there is a short delay period. Dishes containing leftover cooked meat or poultry should not be cooked automatically if there is a delay period.

*Whole poultry must be thoroughly defrosted before placing in the oven.*

*Check that meat and poultry are fully cooked before serving.*

Automatic cooking is not recommended for baked items that require a pre-heated oven such as cakes, cookies and breads.

## Using your Range

### Both ovens

Before using for the first time, heat the ovens to 400°F for 30 minutes to expel manufacturing odors.

The wire racks should always be pushed firmly to the back of the oven.

*Bakeware, meat pans etcetera should be placed level centrally on the oven's wire racks. Keep all trays and containers away from the sides of the oven, as overbrowning of the food may occur.*

For even browning, the maximum recommended size of a baking sheet is 11 <sup>3</sup>/<sub>8</sub>" x 13" in the main oven and 9" x 12 <sup>1</sup>/<sub>2</sub>" in the Tall oven.

*Cooking high moisture content foods can create a 'steam burst', when the oven door is opened. When opening the oven stand well back and allow any steam to disperse.*



When the oven is on, don't leave the door open for longer than necessary, otherwise the knobs may get very hot.

- Always leave a 'fingers width' between dishes on the same rack. This allows the heat to circulate freely around them.
- Cover meat when cooking to avoid fat splashes.



- To reduce fat splashing when you add vegetables to hot fat around a roast, dry them thoroughly or brush lightly with cooking oil.
- Sufficient heat rises out of the oven while cooking to warm plates in the broiler compartment.
- If you want to brown the base of a pastry dish, preheat the baking sheet for 15 minutes before placing the dish in the centre of the sheet or use the base heat in the Multifunction oven.
- Where dishes may boil and spill over during cooking, place them on a baking sheet.

### Multi-function oven

The left hand oven of your range is Multi-function. It has many varied uses. We suggest you keep a careful eye on your cooking until you are familiar with each function. Remember - not all functions will be suitable for all food types.

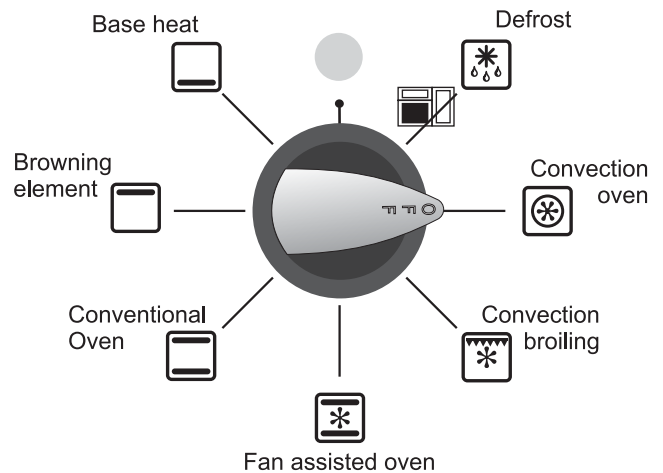

Please remember that all ranges vary - temperatures in your new ovens may differ to those in your previous range.

### Multi-function oven functions



#### Defrost

This function operates the fan to circulate cold air only. No heat is applied. This enables small items such as desserts, cream cakes and pieces of meat, fish and poultry to be defrosted.

Defrosting in this way speeds up the process and protects the food from flies. Pieces of meat, fish and poultry should be placed on a rack, over a tray to catch any drips. Be sure to wash the rack and tray after defrosting.

Defrost with the oven door closed.

Large items, such as whole chickens and meat roasts should not be defrosted in this way. We recommend this be carried out in a refrigerator.

Defrosting should not be carried out in a warm oven or when an adjoining oven is in use or still warm.

Ensure that dairy foods, meat and poultry are completely defrosted before cooking.

## Using your Range



### Convection oven

This function operates the fan and the heating element around it. An even heat is produced throughout the oven, allowing you to cook large amounts quickly.

Fan oven cooking is particularly suitable for multi-rack cooking and is a good 'all-round' function. It may be necessary to reduce the temperature by approximately 20°F for recipes previously cooked in a conventional oven.

If you wish to pre-heat the oven, wait until the indicator light has gone out before inserting the food.



### Convection broiling

This function operates the fan whilst the top element is on. It produces a more even, less fierce heat than a conventional broiler. For best results, place the food to be cooked, on a grid over a roasting tin, which should be smaller than a conventional broiler pan. This allows greater air circulation. Thick pieces of meat or fish are ideal for cooking in this way, as the circulated air reduces the fierceness of the heat from the broiler. The oven door should be kept closed whilst cooking is in progress, so saving energy. You will also find that the food needs to be watched and turned less than for normal broiling. Pre-heat this function before cooking.



### Fan assisted oven

This function operates the fan, circulating air heated by the elements at the top and the base of the oven. The combination of fan and conventional cooking (top and base heat) makes this function ideal for cooking large items that need thorough cooking, such as a large meat roast. It is also possible to bake on two racks at one time, although they will need to be swapped over during the cooking time, as the heat at the top of the oven is greater than at the base, when using this function.

This is a fast intensive form of cooking; keep an eye on the food cooking until you have become accustomed to this function.



### Conventional oven (top and base heat)

This function combines the heat from the top and base elements. It is particularly suitable for roasting and baking pastry, cakes and biscuits. Food cooked on the top rack will brown and crisp faster than on the lower rack, because the heat is greater at the top of the oven than at the base, as in 'Convection assisted oven' function. Similar items being cooked will need to be swapped around for even cooking. This means that foods requiring different temperatures can be cooked together, using the cooler zone in the lower half of the oven and hotter area to the top.



### Browning element

This function uses the element in the top of the oven only. It is a useful function for the browning or finishing of pasta dishes, vegetables in sauce and lasagne, the item to be browned being already hot before switching to the top element.



### Base heat

This function uses the base element only. It will crisp up your pizza or quiche base or finish off cooking the base of a pastry case on a lower rack. It is also a gentle heat, good for slow cooking of casseroles in the middle of the oven or for plate warming.

The Browning and Base heat functions are useful additions to your oven, giving you flexibility to finish off items to perfection. With use, you will soon realize how these functions can combine to extend your cooking skills.

## Using your Range

### Handyrack

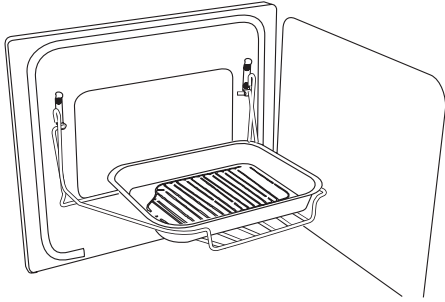

The maximum weight than can be held by the Handyrack is 12lb (5.5kg). It should only be used with the supplied meat tin, which is designed to fit the Handyrack. Any other vessel could be unstable.

The Handyrack fits on the oven door. Food cooking on it is easy to attend to, because it's accessible when the door is open. It can be fitted at two different heights. One of the oven racks must be removed and the other positioned to suit.

When the Handyrack is used in its highest position, other dishes can be cooked on the bottom shelf position of the oven or standing on the base of the oven

When the Handyrack is used in its lowest position, other dishes can be cooked on the second rack position of the oven or standing on the base of the oven.

To fit the Handyrack, locate one side of it on the door bracket.

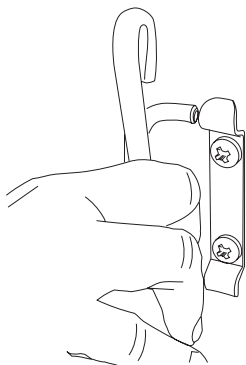
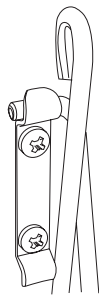

Then spring the other side out to clip it onto the other bracket.

### Main Oven racks

Top view

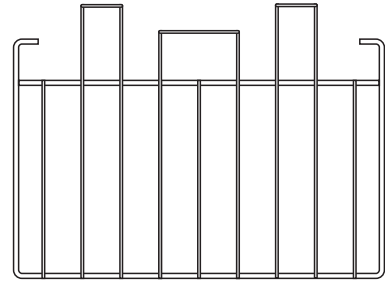

Side view



the rack guard should be at the back pointing upwards

As well as the flat racks some models are supplied with drop racks The drop racks increases the possibilities for oven rack spacing.

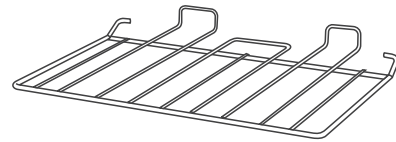

flat rack

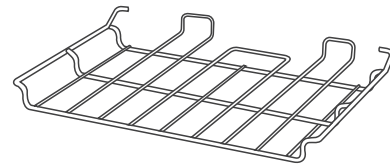

drop rack

The oven racks can be easily removed and refitted.

Pull the rack forward until the back of the rack is stopped by the rack stop bumps in the oven sides.

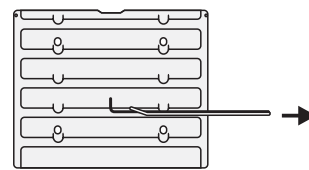

Lift up the front of the rack so the back of the rack will pass under the rack stop and then pull the rack forward.

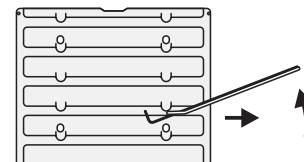

## Using your Range

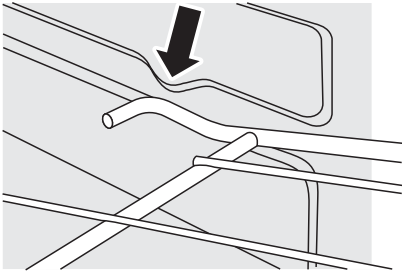

To refit the rack, line up the rack with a groove in the oven side and push the rack back until the ends hit the rack stop. Lift up the front so the rack ends clear the rack stops, and then lower the front so that the rack is level and push it fully back.

## Tall oven racks

The tall oven is supplied with four normal cooking racks

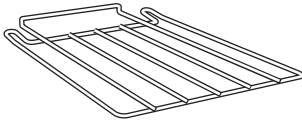

and a plate warming rack.

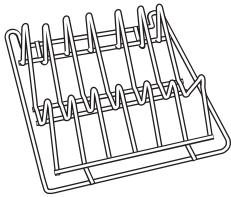

When using the tall oven you can cook on all four racks at the same time; but make sure they are well spaced out to allow the hot air to circulate.

## Steam

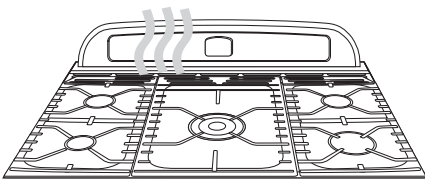

When cooking foods with high water content (e.g. oven fries) there may be some steam visible at the grille at the rear of the cooktop. This is perfectly normal.

## Oven light



Press the button to turn on the Main oven light.

If the oven light fails, turn off the power supply before you change the bulb. See the 'Troubleshooting' section for details on how to change an oven light bulb.

## Using your Range

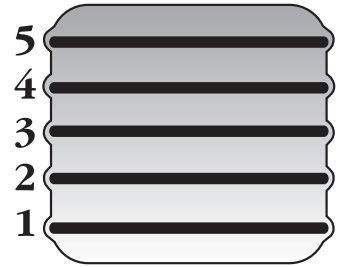
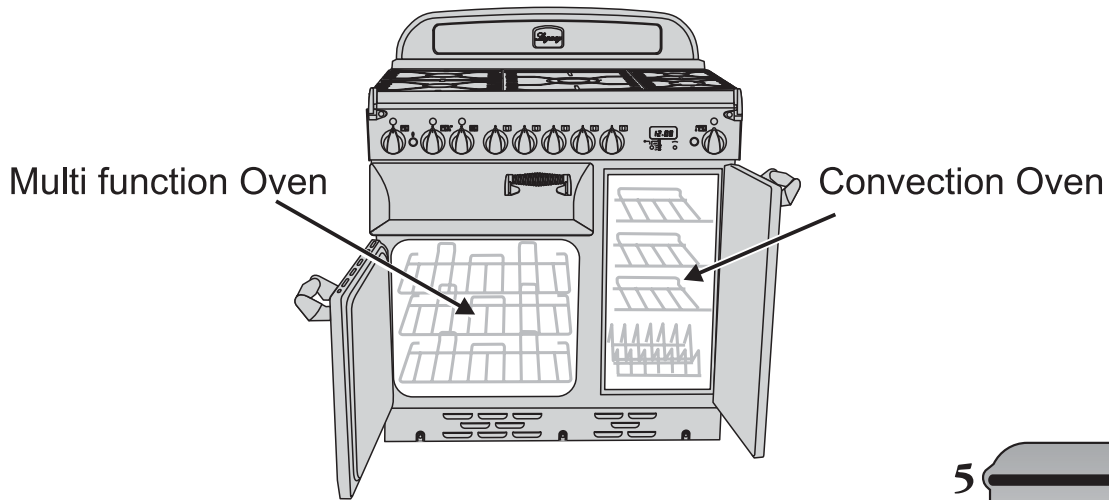

### Multi-function (Left hand) Oven cooking guide

*Remember - not all functions will be suitable for all food types. The oven control settings and cooking times given are intended to be used only as a guide. Individual tastes may require the temperature to be altered to provide a preferred result.*

*Food is cooked at a lower temperature in a convection oven than in a conventional oven. When using recipes, reduce the temperature by 20°F and the cooking time by 5-10 minutes. The temperature in the convection oven is the same throughout ensuring uniform results.*

*The racks should not be fitted directly one above the other. When cooking on more than one rack always leave at least one runner space between them. Place baking sheets, individual cake tins or baking dishes centrally on the oven rack. For best results pre-heat the oven until the oven indicator light goes out.*

### Cooking chart - Fan assisted oven mode



Food	Temp	Oven Rack Position	Approximate Cooking Time
Cup cake	340°F	2-4	20 min
Scone (British)	350°F	2-4	15 min
Deep apple pie	350°F	2-4	45 min interchange after 25 minutes according to size.
Plate tart	375°F	2-4	45 min interchange After 25 minutes according to size.
Fruit cake 8" x 3 1/2"	225°F	3	1 hr 45 min - 2 hr
Puff pastry	425°F	3 - 5	15-40 mins according to size. Interchange 2/3rds through cooking time
Angel food cake	325°F	3	50 - 60 minutes
Brownies	350°F	2-4	25 - 30 min interchange after 15 minutes
Muffins	350°F	2-4	25 - 25 min interchange after 15 minutes
Cookies	350°F	2-4	10 - 15 min interchange after 8 minutes
Pound cake	350°F	3	40 - 60 minutes

For roast meats and poultry refer to the Convection oven guide - reduce cooking time slightly.

Ensure meat and poultry is fully cooked before serving

## Using your Range

### Cooking chart



Food	Conventional Oven		Convection Oven	Approximate Cooking Time
	Temp	Rack Position	Temp	
<b>FISH</b>				
	375°F	3	350°F	Fillets 15-20mins.
	375°F	3	350°F	Whole 10mins.per lb + 10mins.
	375°F	3	350°F	Steaks according to thickness.
<b>ROAST MEATS</b>				
Beef with bone	325°F	2-3	300°F	20-25mins. per lb + 20-25mins.
	400°F	2-3	375°F	15-20mins. per lb + 15-20mins.
Beef without bone	325°F	2-3	300°F	30-35mins. per lb + 30-35mins.
	400°F	2-3	375°F	20-25mins. per lb + 20-25mins.
Lamb	325°F	2-3	350°F	30-35mins. per lb + 30-35mins.
	400°F	2-3	375°F	25-35mins. per lb + 25-30mins.
Pork	325°F	2-3	300°F	35-40mins. per lb + 35-40mins.
	400°F	2-3	375°F	25-30mins. per lb + 25-30mins.
Stuffed and rolled - Add approx. 10 mins. per lb to above cooking times or cook at 390°F for 20mins. then 320°F for remainder.				
<b>THOROUGHLY THAW FROZEN MEAT AND POULTRY BEFORE COOKING.</b>				
<b>POULTRY</b>				
Chicken	325°F	2-3	300°F	20-25mins. per lb + 20-25mins.
	400°F	2-3	375°F	15-20mins. per lb + 15-20mins.
Turkey	325°F	1-3	300°F	20-25mins. per lb + 20-25mins.
	400°F	1-3	375°F	15-20mins. per lb + 15-20mins.
Stuffed Poultry - Cook at 390°F or at 390°F for 20mins. then 320°F for remainder. Prepacked (fresh or frozen) follow packers cooking times				
<b>CASSEROLE</b>	300-325°F	2-3	300°F	2-4hrs according to recipe.
<b>YORKSHIRE PUDDING</b>	425°F	4	400°F	Large tin 30-35mins. Individual 10-20mins.
<b>CAKES</b>				
Rich fruit (7")	300°F	2	275°F	2½-3hrs.
Cup Cakes	375°F	3 & 5 or 3	350°F	15-25mins.
Scones (British)	425°F	2 & 4 or 3	400°F	10-15mins.
<b>PASTRY</b>				
Plate Tart	375°F	2 & 4	350°F	45-50mins. Interchange after 25mins.
Fruit Pie	375°F	2 & 4	350°F	35-40mins. Interchange after 25mins.
Tartlets	375°F	4	350°F	15-20mins. according to size.
Puff Pastry	425°F	2,3 or 4	400°F	20-40mins. according to size.
<b>BREAD</b>	425°F	2 & 4	400°F	20-30mins. according to size.
<b>MERINGUES</b>	230°F	3	225°F	2-2½hrs. according to size.
<b>PUDDINGS</b>				
Baked Egg Custard	325°F	3	300°F	45mins.-1hr.
Baked sponge pudding	375°F	3	350°F	40-45mins. according to size.

## Using your Range

### Cleaning your range

#### *Essential information*

Before thorough cleaning isolate the electricity supply. Remember to switch on the electricity supply before use.

**Never use paint solvents, caustic cleaners, biological powders, bleach, chlorine based bleach cleaners, coarse abrasives or salt. Don't mix different cleaning products - they may react together with hazardous results.**

**Recommended cleaning materials are shown in the chart below.**

MAKE SURE THE FLOW OF COMBUSTION AND VENTILATION AIR TO THE RANGE IS UNOBSTRUCTED -FOR EXAMPLE BY BUILD UP OF FATS OR GREASE.

On Natural Gas the burners flames should be a blueish color with, at most, a slight yellowish fringe.

On Propane gas the flames may be "softer". The cooktop burner flames may have a slight yellowish tip.

If the flame burns with a long white tip you should call for service.

#### Cleaning the Range - Daily care

Cleaning the range is not a welcomed chore, but it has to be done to maintain efficiency and appearance. Remember it is better to wipe up any spills as they occur, this will prevent them burning on and becoming more difficult to remove later.

#### Cleaning for spills

For spills and boil-overs that occur while cooking, as soon as possible turn the burner off and allow to cool. Do not clean until the area is completely cooled down. Wipe up spills as soon as possible.

**Do not allow surplus water to seep into the range.**

#### Cleaning chart

All Parts listed here can be cleaned using hot soapy water (dishwashing liquid detergent) and a soft cloth. For more difficult cleaning, follow the appropriate instruction. Check cleaner manufacturers guidelines for compatibility with the material of your range.

Part	Finish	How to clean
Burner Grates & Burner Caps	Porcelain Enamel	Mildly abrasive cleaner such as Bon -Ami® or Soft Scrub® Dishwasher.
Burner Head	Aluminum	Mildly abrasive cleaner and nylon scourer / soft cloth
Burner bases	Aluminum	As above.
Hotplate Top	Porcelain Enamel	Mildly abrasive cleaner such as Bon-Ami® or Soft Scrub® with a soft cloth
Sides, Plinth	Painted surface	Hot soapy water and soft cloth.
Fascia	Porcelain Enamel	Non-abrasive cleaner, soft cloth.
Oven liners, roof and floor, door interior	Porcelain Enamel	Branded oven cleaner suitable for enamel surfaces.
Door Handles	Chrome/Plastic	Non-abrasive cleaner, hot soapy water, soft cloth
Broiler Grid, Handyrack Oven Racks	Chrome	Dishwasher. Hot soapy water and scouring pad.
Meat tin	Porcelain Enamel	Scouring Pad, hot soapy water. Dishwasher
Broiler Pan	Porcelain Enamel	Mildly abrasive cleaner Scouring Pad
Door surround	Porcelain Enamel	Mildly abrasive cleaner such as Bon-Ami® or Soft Scrub® with a soft cloth. Take care to not damage rubber door seal.
Outer Doors and Drawer	Porcelain Enamel	Multi-surface Cleaner, soft cloth

Carefully read and follow the manufacturers instructions on cleaning products.

## Using your Range

### Cooktop burners

Some models have a separate trim ring, which fits on the burner head.

The burner heads and caps can be removed for cleaning. Make sure they are absolutely dry before replacing.

#### The central cooktop

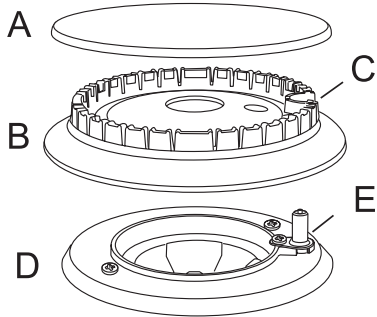

A cap, B head, C notch, D base, E electrode

When refitting the burner head, make sure that the notch lines up with the electrode or hole in the base. Check that the burner head is level and that the cap is fitted centrally on the burner head.

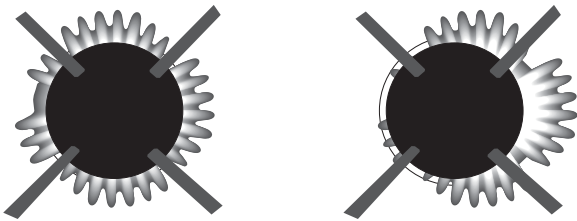

Normal flame appearance

Burner not fitted correctly

### The Wok burner

The Wok burner is a little more complicated but can also be taken apart for cleaning.

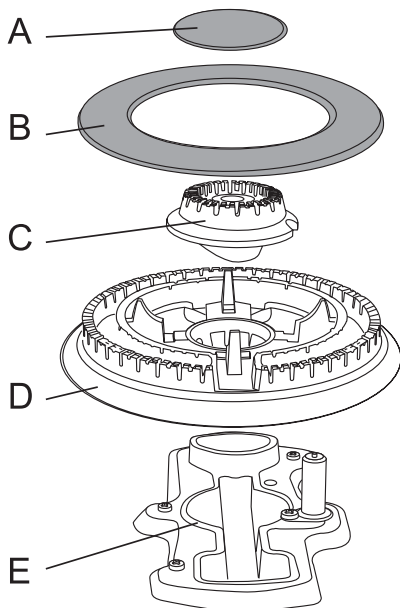

Wok burner

A inner burner cap,  
C inner burner head  
E Wok burner base

B outer burner cap  
D outer burner head

When reassembling the Wok burner, turn over the large base ring and find the 'D' shaped area.

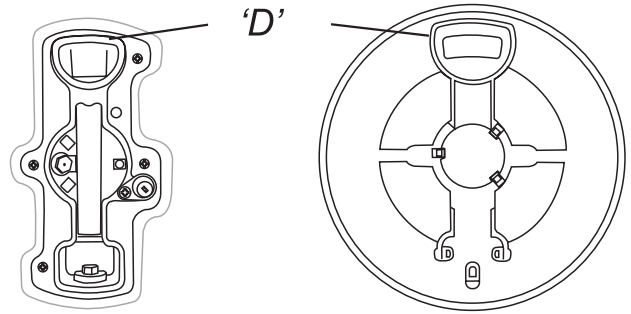

Turn the head until the 'D' matches the one on the burner base. Turn the head over and place it on the burner base. To fit the small inner burner, find the larger electrode notch in the burner rim. Line this up with the white ignition electrode and place the inner burner on the large base ring.

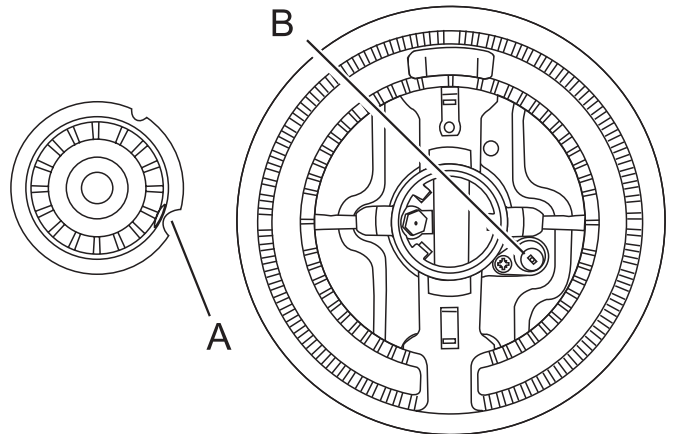

A electrode notch

B ignition electrode

Now fit the two trim rings, making sure that they are sitting down properly.

### Broiler

The broiler pan and grid should be washed in hot soapy water. After cooking meats or any foods that soil, leave to soak for a few minutes in the sink immediately after use. Stubborn particles may be removed from the grid by using a nylon brush.

### Control Panel and Doors

Avoid using any abrasive cleaners including cream cleaners, on brushed Stainless Steel surfaces. For best results use a liquid detergent.

The control panel and control knobs should only be cleaned with a soft cloth wrung out in clean hot soapy water. Wipe with a clean dampened cloth then polish with a dry cloth. The oven doors should only be cleaned with a soft cloth wrung out in clean hot soapy water.

# Using your Range

## Ovens

The main oven side lining panels can be removed for cleaning and for cleaning behind. They can also be put into a dishwasher. Remove the racks first.

Each side of the oven is fixed with four fixing screws. You don't have to remove the screws to remove the oven linings. Lift each side panel upwards and they will slide off the screws. Then pull them forwards.

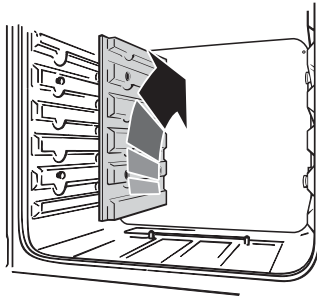

Once the linings are removed, the oven enamel interior can be cleaned.

When replacing the linings fit the side linings first.

## The Tall Oven

To clean the oven sides slide out the racks, unhook the supports from the oven sides and lift out.

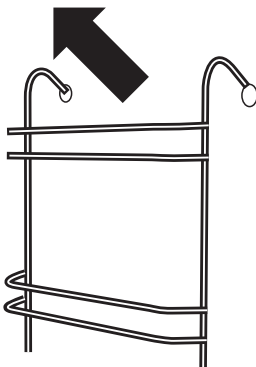

## Troubleshooting

### Steam is coming from the oven

When cooking foods with a high water content (e.g. oven fries) there may be some steam visible at the rear grille. Take care when opening the oven door, as there may be a momentary puff of steam when the oven door is opened. Stand well back and allow any steam to disperse.

### The oven fan is noisy

The note of the oven fan may change as the oven heats up - this is perfectly normal.

### What cleaning materials are recommended for the range?

See the 'Cleaning' section for a full list of recommended cleaning materials. We do not recommend corrosive or caustic cleaners as these may damage your range.

### The knobs get hot when I use the oven or the broiler, can I avoid this?

Yes, this is caused by heat rising from the oven or the broiler, and heating them up. Don't leave the oven door open. Make sure that the broiler pan is pushed right back to the 'backstop' when broiling.

### If there is an installation problem and I don't get my original installer to come back to fix it who pays?

You do. Service organizations will charge for their call outs if they are correcting work carried out by your original installer. It's in your interest to track down your original installer.

### Current Operated Ground Fault Circuit Breaker

Where the range installation is protected by a 30 milliamp sensitivity residual current device (RCD), the combined use of your range and other domestic appliances may occasionally cause nuisance tripping. In these instances the range circuit may need to be protected by fitting 100mA device. This work should be carried out by a qualified electrician.

### Food is cooking too slowly, too quickly, or burning

Cooking times may differ from your previous oven. Check that you are using the recommended temperatures and rack positions. See pages 16 -17. The oven control settings and cooking times are intended to be used only as a guide. Individual tastes may require the temperature to be altered either way, to get the results you want. Try cooking at a higher temperature setting. Is the oven roof in?

## Using your Range

### The oven is not cooking evenly

Do not use a tin or tray larger than 11  $\frac{3}{8}$ " x 13" in the main oven or 9" x 12  $\frac{1}{2}$ " in the Tall oven. If you are cooking a large item, be prepared to turn it round during cooking.

If two racks are used, check that space has been left for the heat to circulate. When a baking sheet is put into the oven, make sure it is placed centrally on the rack.

Check that the door seal is not damaged and that the door catch is adjusted so that the door is held firmly against the seal.

A dish of water when placed on the rack should be the same depth all over. (For example, if it is deeper at the back, then the back of the range should be raised up or the front lowered). If the range is not level arrange for your supplier to level it for you.

### Oven not coming on when turned on manually

Is the power on? Is the clock illuminated?

If not there may be something wrong with the power supply. Is the range supply on at the isolator switch?

Has the time of day been set?

If using the Multi-function oven have you set a cooking function?

Is the key symbol (Ⓘ) showing in the display? See the Clock section of the instructions for more information on the key lock feature of the clock.

### Oven not coming on when automatic cooking

Timer set correctly but oven knob left OFF by mistake?

Is the key symbol (Ⓘ) showing in the display? See the Clock section of the instructions for more information on the key lock feature of the clock.

If using the Multi-function oven have you set a cooking function?

### Oven temperature getting hotter as the range gets older

If turning the knob down has not worked or only worked for a short time then you may need a new thermostat. This should be fitted by a service person.

### Broiler not cooking properly

Are you using the pan and grid supplied with the range? Is the pan being used on the runners, not the floor of the compartment? Is the broiler tray pushed fully back to stop?

### The oven light is not working

The bulb has probably burnt out. You can buy a replacement bulb (which is not covered under the guarantee) from a good electrical shop. Ask for a 15w 125-130v lamp, FOR OVENS. It must be a special bulb, heat resistant to 300°C (570°F).

Make sure the oven is cool. Open the oven door and remove the Handyrack (if fitted) and oven racks.

#### Turn off the power supply.

Unscrew the bulb cover by turning counter clockwise. Unscrew the old bulb. Screw in the new bulb, screw back the bulb cover. Turn on the electricity supply and check that the bulb now lights.

### Cooktop ignition or cooktop burners faulty

Is the power on? Is the clock illuminated? If not there maybe something wrong with the power supply.

See 'power supply' section further on.

Are the sparker (ignition electrode) or burner slots blocked by debris?

Is the burner trim correctly located?

Are the burner caps correctly located?

See the section entitled 'Cleaning'

Remember that each cooktop burner has a special safety device that stops the flow of gas if the flame goes out. When lighting a cooktop burner the safety device has to be overridden by holding the control knob so that the gas can flow. This allows the flame sensor to heat up and operate the safety device. Keep holding the knob pressed in to let the gas through to the burner for few seconds. The igniter should spark and light the gas.

If, when you let go of the control knob, the burner goes out, the safety device has not held in. Turn the control to the off position and wait one minute, then try again this time holding in the control knob for slightly longer.

### Cooktop burners will not light

If only one or all the cooktop burners will not light, make sure that the parts have been replaced correctly after wiping or removing for cleaning.

Check that there is not a problem with your gas supply. You can do this by making sure that other gas appliances you may have are working.

Do the burners spark when you push the button? If not check the power is on - is the clock illuminated?

## Using your Range

### Service and spares

Please complete the appliance details below and keep them safe for future reference - this information will enable us to accurately identify your particular appliance and help us to help you. Filling this in now will save you time and inconvenience if you later have a problem with your appliance. It may also be of benefit to keep your purchase receipt with this leaflet. You may be required to produce the receipt to validate a warranty field visit.

Fuel Type: <b>Dual Fuel</b>
Name of Appliance & Color* <b>AGA Legacy 36</b>
Appliance Serial Number *
Retailers Name & Address
Date of Purchase
Installers Name & Address
Date of Installation

\* This information is on the appliance data badge.

### If you have a problem

In the unlikely event that you have a problem with your appliance, please refer to the rest of this booklet, especially the problem solving section, first to check that you are using the appliance correctly.

If you are still having difficulty, contact : -

Technical Services Dept. AGA-Ranges Inc.  
110 Woodcrest Road  
Cherry Hill  
NJ 08003

Telephone Number 1-800-633-9200

Email support@aga-ranges.com

### Please note

If your appliance is outside the warranty period, our service provider may charge for this visit.

If you request an engineer to visit and the fault is not the responsibility of the manufacturer, our service provider reserves the right to make a charge.

Appointments not kept by you may be subject to a charge.

### Out of Warranty

We recommend that our appliances are serviced regularly throughout their life to maintain the best performance and efficiency.

Service work should only be carried out by technically competent and suitably qualified personnel.

### Spare Parts

To maintain optimum and safe performance, only use genuine spare parts. Do not use re-conditioned or unauthorised gas controls. Contact your retailer.

Read all instructions before installing or using this appliance.

## Installation Instructions

**Save these instructions for future reference.**

# Installation

**This book contains many important safety messages.**

**Always read and obey all safety messages.**

**Installer: Leave these instructions with the appliance**

# WARNING

If the information in this manual is not followed exactly, a fire or explosion may result causing property damage, personal injury or death.

Do not **store or use gasoline or other flammable vapors and liquids in the vicinity of this or any other appliance.**

## WHAT TO DO IF YOU SMELL GAS

Do not **try to light any appliance.**

Do not **touch any electrical switch**

Do not **use any phone in your building.**

Immediately **call your gas supplier from a neighbor's phone. Follow the gas supplier's instructions.**

If you cannot reach your gas supplier, call the fire department.

**Installation and service must be performed by a qualified installer, service agency or the gas supplier.**

# Warning

The anti-tip device supplied with this range must be correctly fitted when the appliance is installed. This will reduce risk of tipping of the appliance from abnormal usage or by excessive loading of the oven door

	<p><b>⚠ WARNING</b></p> <ul style="list-style-type: none"><li>• ALL RANGES CAN TIP</li><li>• INJURY TO PERSONS COULD RESULT</li><li>• INSTALL ANTI-TIP BRACKET PACKED WITH RANGE</li><li>• SEE INSTALLATION INSTRUCTIONS</li></ul>
---	--

Regulations	Page 30
If you smell gas	Page 30
Tools	Page 30
Materials	Page 30
Installation Safety Instructions	Page 31
Dimensions and clearances	Page 32
Location guidelines	Page 33
Moving the Range	Page 33
Checking the parts	Page 34
Leveling the Range	Page 35
Anti-Tip Device	Page 35
Gas Connection	Page 35
Electrical Connection	Page 37
Assemble the range	Page 41
Range operational checks	Page 43
Conversion to an other gas	Page 44
Schematic diagram of the Range	Page 46
Technical Data	Page 48

Read all instructions before installing or using this appliance.

## Installation Instructions

Save these instructions for future reference.

### Regulations

Installation of this range must conform with local codes, or in the absence of local codes, with the National Fuel Gas Code, ANSI Z223.1/NFPA.54, latest edition.

In Canada, installation must conform with the current Natural Gas Installation Code, CAN/CGA-B149.1 or the current Propane Installation Code, CAN/CGA-B149.2, and with local codes where applicable.

This range has been design-certified by CSA International according to ANSI Z21.1, latest edition and CAN/CGA-22.2 latest edition.

Read the instructions before installing or using this appliance. This range becomes hot in use, the cooktop burners produce exhaust gases. Take safety precautions - see the safety warnings in the User Guide, which should be read together with this installation guide.

The range must be electrically grounded in accordance with local codes or, in the absence of local codes, in accordance with the National Electrical Code (ANSI/NFPA 70, latest edition). In Canada, electrical grounding must be in accordance with the current CSA C22.1 Canadian Electrical Code Part 1 and/or local codes. See 'Electrical Connection' in this section

### Important

- Observe all governing codes and ordinances.
- The range must be properly grounded.
- Save these instructions for the local electrical inspector's use.

### For Your Safety

Do not store or use combustible materials, gasoline or other flammable vapors and liquids in the vicinity of this or any other appliance.

### If you smell gas

- **Open windows.**
- **Don't touch electrical switches.**
- **Extinguish any open flame.**
- **Immediately call your gas supplier**

### Tools

#### You will need the following tools

1. Electric drill
2. Masonry drill bit & anchors (only required if fitting the range on a stone or concrete floor)
3. Steel tape measure
4. Phillips head screwdriver
5. Flat head screwdriver
6. 4mm & 3mm Allen keys
7. Spirit level
8. Pencil
9. Open-end or adjustable wrench
10. Pencil and ruler
11. Pipe wrenches

### Materials

#### Additional materials you may need:

- Gas line shut-off valve
- Pipe joint sealant or UL-approved pipe thread tape with Teflon\* that resists action of natural and LP gases. \*Teflon: Registered trademark of DuPont
- Flexible metal appliance connector (1/2" I.D.). A 5-foot length is recommended for ease of installation but other lengths are acceptable. Never use an old connector when installing a new range.
- Flare union adapter for connection to gas supply line (3/4" or 1/2" NPT x 1/2" I.D.)
- Flare union adapter for connection to pressure regulator on range (1/2" NPT x 1/2" I.D.)
- To protect any floor covering under the range a sheet of 1/4" thick ply wood or equivalent large enough to stand the range on

Read all instructions before installing or using this appliance.

## Installation Instructions

**Save these instructions for future reference.**

### Installation Safety Instructions

#### **Warning!**

Improper installation, adjustment, alteration, service or maintenance can cause injury or property damage. Refer to this manual. For assistance or additional information, consult a qualified installer, service agency, manufacturer (dealer) or the gas supplier. Never reuse old flexible connectors. The use of old flexible connectors can cause gas leaks and personal injury. Always use NEW flexible connectors when installing a gas appliance.

#### **Important**

Remove all packing material and literature from oven before connecting gas and electrical supply to range.

- Have your range installed by a qualified installer.
- Your range must be electrically grounded in accordance with local codes or, in the absence of local codes, in accordance with the National Electrical Code (ANSI/NFPA 70, latest edition).
- Before installing your range on linoleum or any other synthetic floor covering, make sure the floor covering can withstand 180°F without shrinking, warping or discoloring. Do not install the range over carpeting unless a sheet of 1/4" thick plywood or similar insulator is placed between the range and carpeting.
- Make sure the wall coverings around the range can withstand heat generated by the range up to 200°F.
- Avoid placing cabinets above the range. There must be a gap of at least 30" (76cm) between the top of the range and any combustible surface above it.

If a ventilating hood is installed above the range follow the installation instructions supplied with the hood.

#### **Caution**

Items of interest to children should not be stored above a range - children climbing on the range to reach items could be seriously injured.

#### **Converting to LP Gas**

This appliance is supplied set for Natural gas.

A conversion kit for Propane gas is supplied with the range.

If the appliance is to be converted this must be done before installation. The conversion must be performed by a qualified LP gas installer. See the Conversion section at the back of this installation manual for more details.

Read all instructions before installing or using this appliance.

## Installation Instructions

Save these instructions for future reference.

### Dimensions and clearances

Provide adequate clearances between the range and adjacent combustible surfaces. These dimensions must be met for safe use of your range. The location of the electrical outlet and pipe opening (see Gas Pipe and Electric Outlet Locations) may be adjusted to meet specific requirements.

### Positioning the Range

The diagrams below show the minimum recommended distance from the range to nearby surfaces.

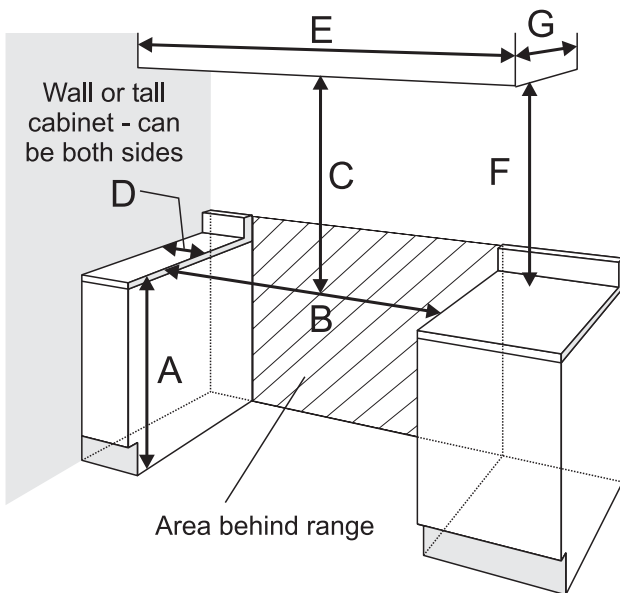

A Min 35-3/8" (89.8cm) Max 36-7/16 (92.5cm)

B Min. 35-13/16" (91cm)

for Canada Min 36-7/16" (92.5cm)

C Min. 30" (76cm)

D Min. 3" (7.5cm) but see below about door opening.

E Min. 50" (127cm)

F Min 18" (43cm)

G Maximum 13" (33cm)

The cooktop surround should be level with, or above, any adjacent work surface. Above cooktop level a gap of 3" should be left between each side of the range and any adjacent vertical surface.

For non-combustible surfaces (such as unpainted metal or ceramic tiles) this can be reduced to 1".

A minimum space of 30" is required between the top of the cooktop and a horizontal combustible surface.

The maximum depth for cabinets installed above cooktops is 13".

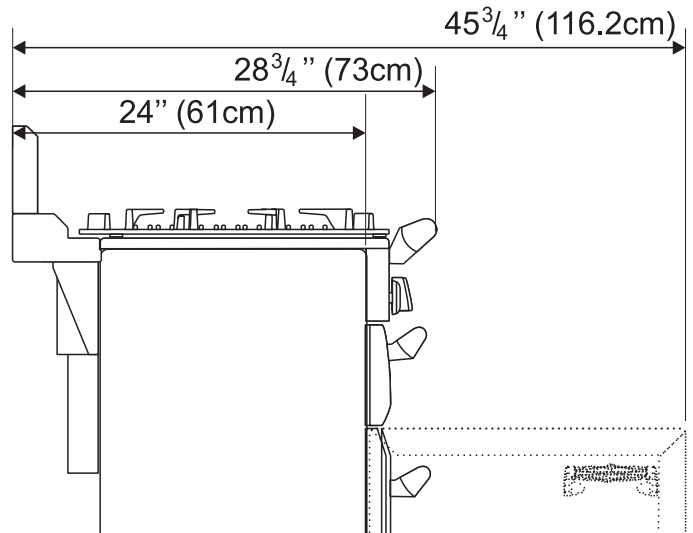

Any range hood should be installed in accordance with the hood manufacturer's instructions.

For safety reasons curtains must not be fitted immediately behind the range.

We recommend a gap of 35-13/16" (for Canada Min 36-7/16" (92.5cm)) between units to allow for moving the range.

If a flush fit is required (USA only), fit the range up to the unit at one side then fit the unit the other side.

A clearance of 5" (13cm) is required if the range is near a corner of the kitchen to allow the oven doors to open.

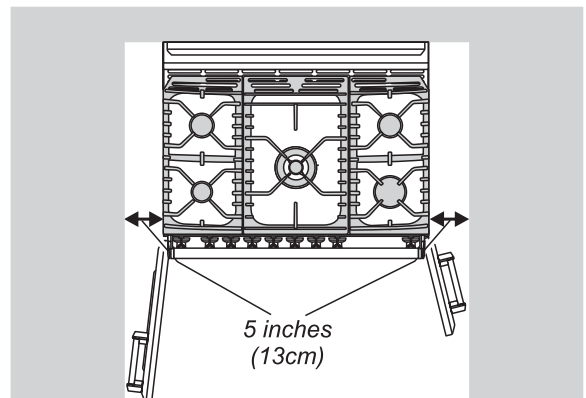

Read all instructions before installing or using this appliance.

## Installation Instructions

Save these instructions for future reference.

### Location guidelines

Do not locate the range where it may be subject to strong drafts. Any openings in the floor or wall behind the range should be sealed. Make sure the openings around the base of the range that supply fresh air for combustion and ventilation are not obstructed by carpeting or woodwork.

Your range is heavy and can settle into soft floor coverings such as cushioned vinyl or carpeting. Use care when moving the range on this type of flooring. It is recommended that the following simple and inexpensive instructions be followed to protect your floor.

The range should be installed on a sheet of plywood (or similar material). When the floor covering ends at the front of the range, the area that the range will rest on should be built up with plywood to the same level or higher than the floor covering.

This will allow the range to be moved for cleaning or servicing. Also, make sure your floor covering will withstand 180°F. (See the Installation Safety Instructions section.)

Make sure the wall coverings around your range can withstand the heat generated (up to 200°F) by the range. (See the Installation Safety Instructions section.)

### Moving the Range

The range is very heavy. Take great care. We recommend two people maneuver the range. Ensure that the floor covering is firmly attached, or removed to prevent it being disturbed when moving the range around. You will need the leveling tool.

From the back tilt the range forward and remove the rear half of the polystyrene base pack.

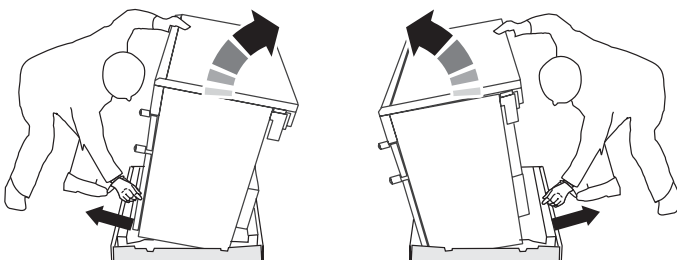

Repeat from the front and remove the front half of the polystyrene base.

**LOWER THE TWO REAR ROLLERS.**

First fit the levelling tool on the hexagonal adjusting nut as shown below.

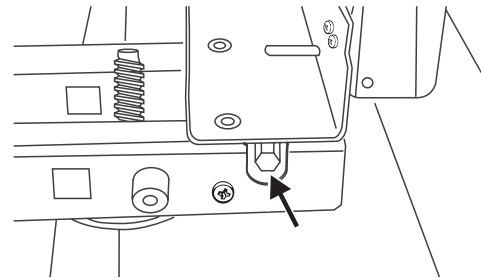

Make 10 complete (360°) turns clockwise. (This means turning and removing the levelling tool 20 times).

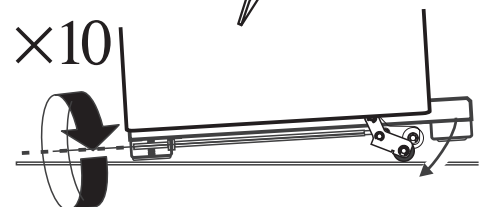
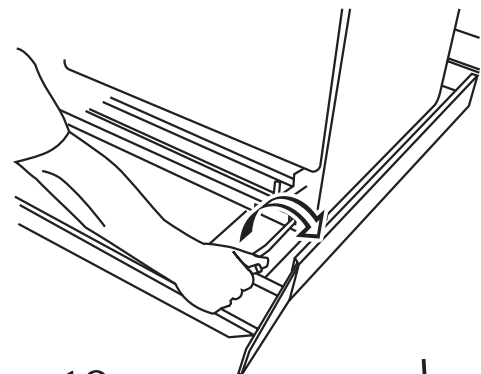

Make sure you lower **BOTH REAR ROLLERS**. There are two adjusting nuts, one for each roller, at both the front bottom corners of the range.

**Note the rollers are only intended to aid installation - the range should not be moved once it is installed.**

Unfold the rear edge of pack base tray. Open the grill door and the Tall oven door. Grip under the control panel and lift the front of the range.

Read all instructions before installing or using this appliance.

# Installation Instructions

Save these instructions for future reference.

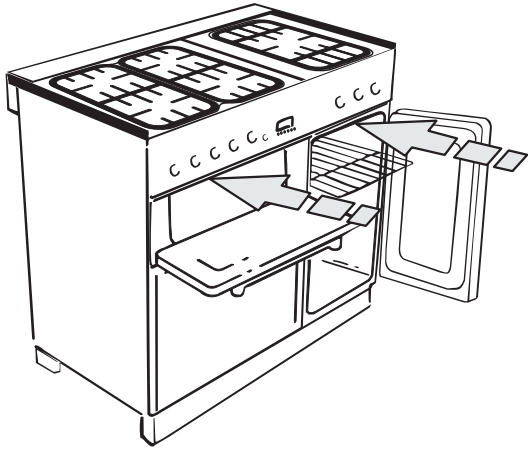

Carefully push the range backwards off the pack base. Remove the pack base tray. Position the range close to its final position leaving just enough space to get behind it.

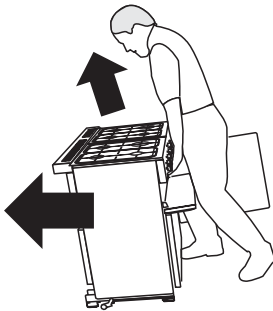

Do not use the door handles or control knobs to maneuver the range. Use the cooktop and bowl areas.

## IMPORTANT!

Remove all tape and packaging. Make sure the burners are properly seated and level. Take the accessory pack out of the oven. Check to be sure that no range parts have come loose during shipping.

## Checking the parts

Check that the range has the following parts.

### 3 grates

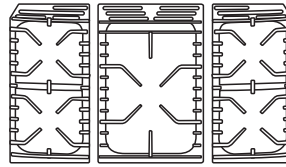

### Broiler pan and trivet

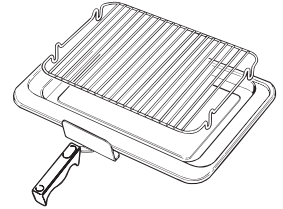

### Leveling tool

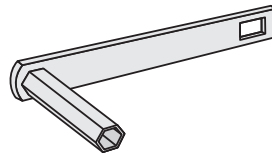

### Handyrack

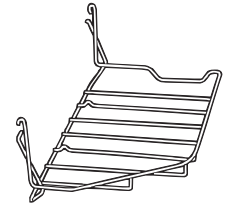

### Meat tin

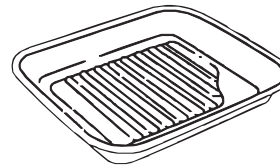

### 3 Main oven racks

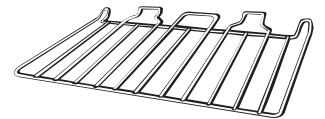

### Tall oven racks & rack supports

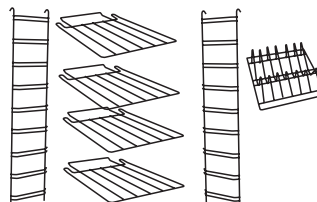

### Splashback & Plinth supports

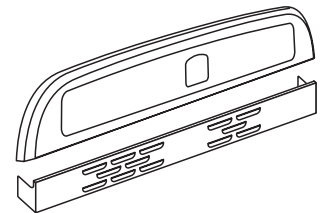

### Conversion kit from Natural gas to LP gas

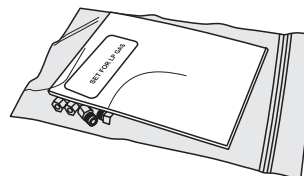

### Rear spacer

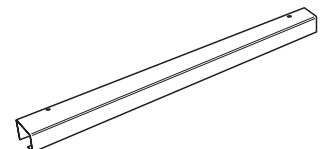

Read all instructions before installing or using this appliance.

## Installation Instructions

Save these instructions for future reference.

### Leveling the Range

Place the range in its intended position taking care not to twist it within the gap between the kitchen units as damage may occur to the range or the units. Install the oven shelves in the oven. Check for levelness by placing a spirit level or a cup, partially filled with water, on one of the oven grids. If using a spirit level, take two readings—with the level placed diagonally first in one direction and then the other.

The front feet and rear rollers can be adjusted to level the range. To adjust the height of the rear of the range use the leveling tool supplied to turn the adjusting nuts at the front bottom corners of the range. To set the front feet turn the bases to raise or lower.

### Anti-Tip Device

#### WARNING

Range must be secured by Anti-Tip bracket supplied. See instructions to install (supplied with bracket). Unless properly installed, the range could be tipped by leaning on the door. Injury might result from spilled hot liquids or from the range itself.

#### Installing the Anti-Tip Device

The Anti-Tip bracket is supplied with instructions for installation in a variety of locations. The instructions include all necessary information to complete the installation. Read the Safety Instructions and the instructions that fit your situation before beginning installation.

### Gas Connection

#### Gas Supply Requirements

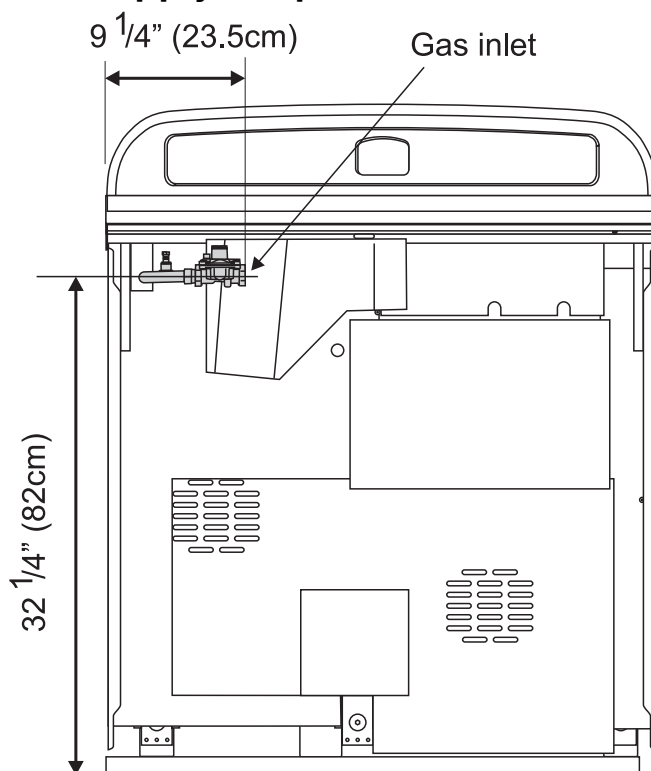

#### Provide Adequate Gas Supply

Prior to installation, ensure that the local distribution conditions (nature of the gas and gas pressure) and the adjustment of the appliance are compatible.

The range is designed to operate at a manifold pressure of 4" of water column on natural gas. A conversion kit for LP gas (propane or butane) is supplied with the range. When converted to LP gas, a pressure of 10" of water column is required.

Make sure you are supplying your range with the correct type of gas.

If the range is to be used on LP gas, a qualified LP installer must convert it. We recommend that the range be converted before installation. This must be done before the range can be used on LP gas.

For proper operation, the pressure of natural gas supplied to the regulator must be between 4 1/2" and 13" of water column.

Read all instructions before installing or using this appliance.

## Installation Instructions

Save these instructions for future reference.

For LP gas, the pressure supplied must be between 10" and 13" of water column.

When checking for proper operation of the regulator, the inlet pressure must be at least 1" greater than the operating (manifold) pressure as given above.

The pressure regulator located at the inlet of the range manifold must remain in the supply line regardless of whether natural or LP gas is being used.

A flexible metal appliance connector used to connect the range to the gas supply line should have an I.D. of 1/2" and be 5 feet in length for ease of installation.

### Connect the Range to the Gas Supply

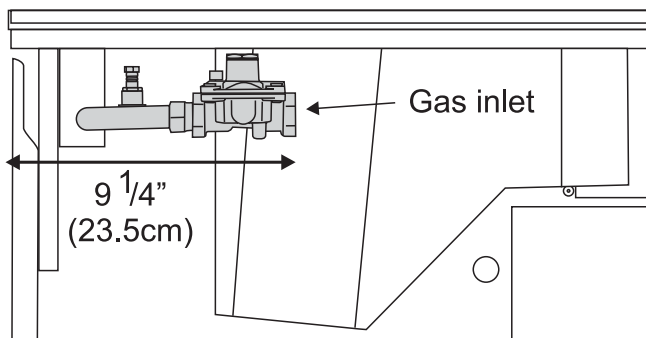

*view from back of range*

Shut off the main gas supply valve before disconnecting the old range and leave it off until the new hookup has been completed. Don't forget to relight the pilot on other gas appliances when you turn the gas back on.

Because hard piping restricts movement of the range, the use of a CSA International-certified flexible metal appliance connector is recommended unless local codes require a hard-piped connection.

Never use an old connector when installing a new range. If the hard piping method is used, you must carefully align the pipe; the range cannot be moved after the connection is made. To prevent gas leaks, put pipe joint compound on, or wrap pipe thread tape with Teflon\* around, all male (external) pipe threads.

\*Teflon: Registered trademark of DuPont

A Install a manual gas line shut-off valve in the gas line in an easily accessed location outside of the range. Make sure everyone operating the range knows where and how to shut off the gas supply to the range.

B If the hotplate grids are fitted remove them. Remove the two screws holding the rear flue grille and remove the grille.

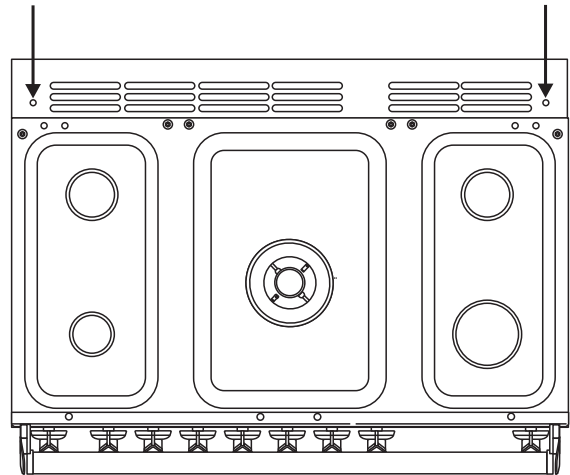

Put the flue grille to one side - you will need it latter.

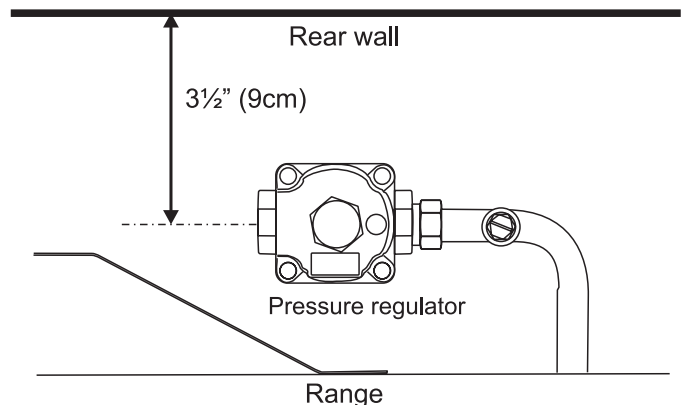

*view from above with the flue grille removed*

C Install male 1/2" flare union adapter to the 1/2" NPT internal thread elbow at inlet of regulator. Use a backup wrench on the regulator fitting to avoid damage. When installing the range from the front, remove the 90° elbow for easier installation.

D Install male 1/2" or 3/4" flare union adapter to the NPT internal thread of the manual shut-off valve, taking care to backup the shut-off valve to keep it from turning.

E Connect flexible metal appliance connector to the adapter on the range. Position range to permit connection at the shut-off valve.

Read all instructions before installing or using this appliance.

## Installation Instructions

Save these instructions for future reference.

F When all connections have been made, make sure all range controls are in the off position and turn on the main gas supply valve. Use a liquid leak detector at all joints and connections to check for leaks in the system. Use a product specifically manufactured for leak detection. Leak testing of the appliance shall be conducted in accordance to the manufacturer's instructions.

### CAUTION: DO NOT USE A FLAME TO CHECK FOR GAS LEAKS.

When using test pressures greater than 1/2 psig (3.5kPa) to pressure test the gas supply system of the residence, disconnect the range and individual shut-off valve from the gas supply piping. When using test pressures of 1/2 psig (3.5kPa) or less to test the gas supply system, simply isolate the range from the gas supply system by closing the individual shut-off valve.

### Flexible Connector

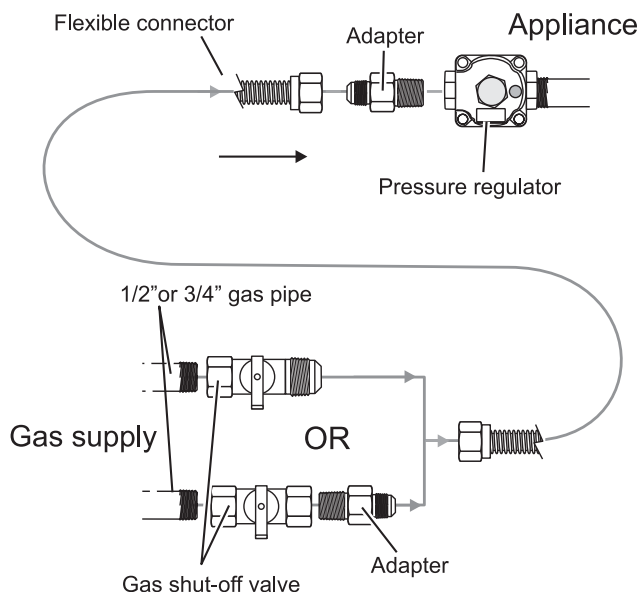

**Installer: Inform the consumer of the location of the gas shut-off valve.**

## Electrical Connection

**When installed the range must be electrically grounded in accordance with local codes or; in the absence of local codes with the National Electrical Code ANSI/NFPA 70, latest edition.**

**In Canada the range must be installed in accordance with the current CSA Standard C22.1 - Canadian Electrical Code Part 1.**

### Electrical Power Supply Requirements

#### Electrical Requirements

**CAUTION: FOR PERSONAL SAFETY, DO NOT USE AN EXTENSION CORD WITH THIS APPLIANCE. REMOVE HOUSE FUSE OR OPEN CIRCUIT BREAKER BEFORE BEGINNING INSTALLATION.**

This appliance must be supplied with the proper voltage and frequency, and connected to an individual, properly grounded branch circuit, protected by a circuit breaker or time-delay fuse, as noted on the rating plate.

Wiring must conform to National Electric Codes. If the electric service provided does not meet the above specifications, have a licensed electrician install an approved outlet.

Because range terminals are not accessible after range is in position, flexible service conduit or cord must be used.

### Provide Proper Electrical Supply

This range must be supplied with 208/240 volt, 60 Hz., and connected to an individual, properly grounded branch circuit protected by a circuit breaker or time-delay fuse (40 amp). The receptacle must be NEMA 14-50R to accept the 4-prong plug supplied with the range.

If the electrical service provided does not meet the above specifications, it is recommended that a licensed electrician install an approved outlet.

Locate the electric supply as illustrated.

Read all instructions before installing or using this appliance.

## Installation Instructions

Save these instructions for future reference.

### Connecting using the supplied cord and plug

Your range is shipped with a 4-prong plug to be used in a NEMA 14-50R receptacle.

Plug the range power cord into a properly grounded wall receptacle.

### Connecting if the supplied cord and plug is not suitable.

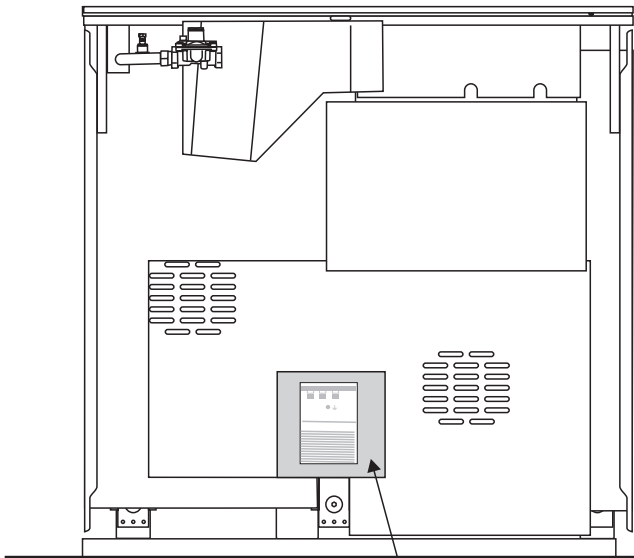

#### Electrical connection cover

To remove the electrical connection cover first remove the screws on the bottom edge.

Slide the cover down to free the top tags.

When refitting the cover first locate it on the top tags and then replace the screws.

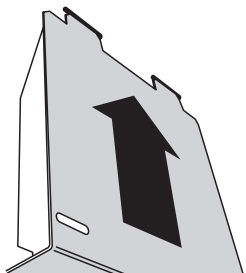

### 4-Wire Conduit Installation

Disconnect the supplied power cord from the terminal block and ground post. Keep the terminal block parts; you will need them. Remove the strain relief clamp from the power cord and remove the power cord and strain relief clamp from the mounting bracket.

The range is shipped with reducer plates to give a 1 1/8" diameter opening for conduit connection. Find the reducer plates in the conversion kit and fit them to the mounting bracket.

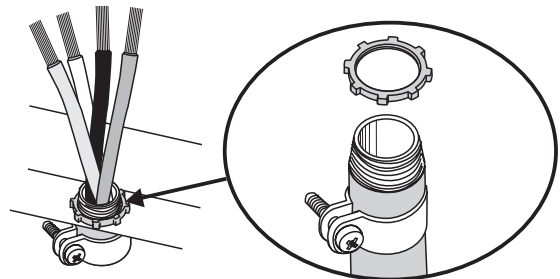

Fit a squeeze connector (not supplied with the range), to your conduit. Insert the conduit through the reducer plates on the mounting bracket. Allow enough slack to easily attach the wires to the terminal block.

**NOTE:** Do not install the conduit without a squeeze connector.

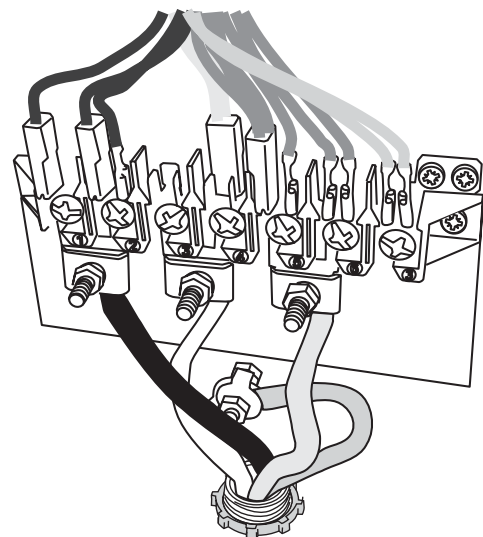

Fit the wires to the ground post and terminal block

**NOTE:** Make sure the wires are completely inserted into the terminals and secure connections are made.

Read all instructions before installing or using this appliance.

## Installation Instructions

Save these instructions for future reference.

Secure the squeeze connector in place in the bracket by tightening the squeeze connector screws.

Refit the electrical connection cover.

### Fitting a 3-Wire Power Cord

Disconnect the supplied power cord from the terminal block and ground post. Keep the terminal block parts; you will need them. Remove the strain relief clamp from the power cord and remove the power cord and strain relief clamp from the mounting bracket. Discard the strain relief clamp.

**NOTE: Do not install the power cord without a strain relief - use the clamp supplied with the cord.**

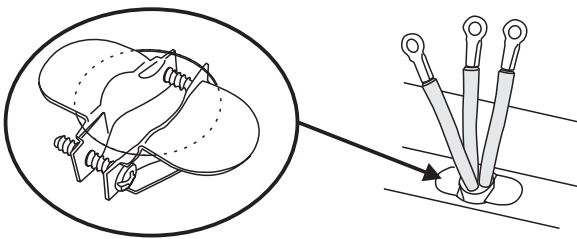

Fit the new strain relief device to the mounting bracket by removing the two clamping screws, feeding the two halves (ears first) through the hole in the mounting bracket and loosely refitting the screws. Insert the power cord through the strain relief device but do not tighten the device yet.

A Ground strap is supplied in the conversion pack.

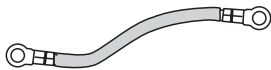

*ground strap.*

Fit the Ground strap to the ground and center terminal of the connector block - see the figure.

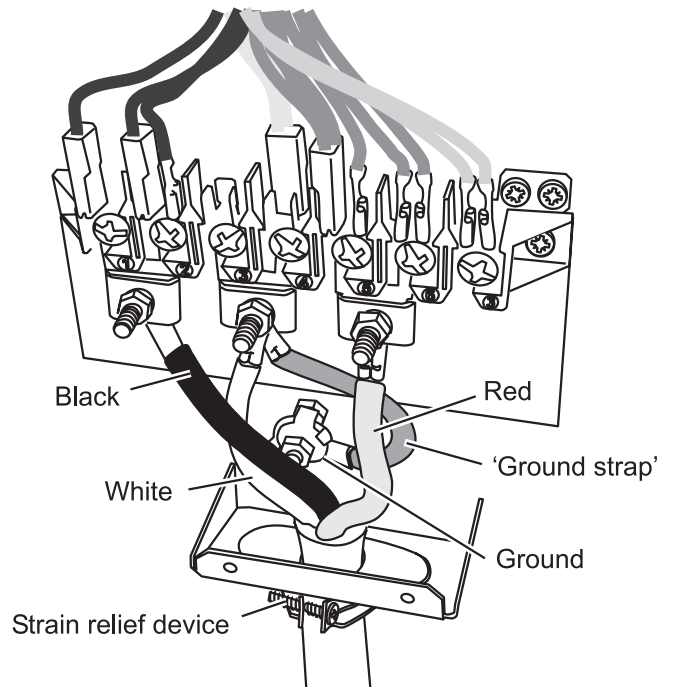

The neutral or ground wire of the power cord must be connected to the neutral terminal located in the center of the connector block. The power leads must be connected to the outside terminals.

Make sure the connections are tight. Now tighten the strain relief device to clamp the power cord.

Refit the electrical connection cover

### 3-Wire Conduit Installation

Disconnect the supplied power cord from the terminal block and ground post. Keep the terminal block parts; you will need them. Remove the strain relief clamp from the power cord and remove the power cord and strain relief clamp from the mounting bracket.

The range is shipped with reducer plates to give a 1 1/8" diameter opening for conduit connection. Find the reducer plates in the conversion kit and fit them to the mounting bracket.

Read all instructions before installing or using this appliance.

## Installation Instructions

Save these instructions for future reference.

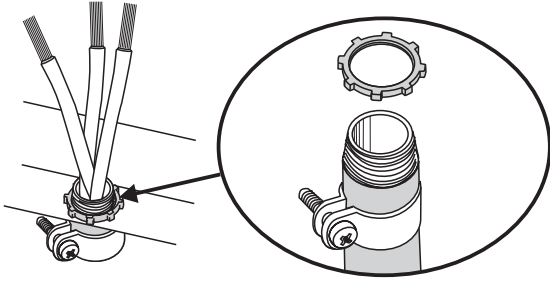

Fit a squeeze connector (not supplied with the range), to your conduit. Insert the conduit through the reducer plates on the mounting bracket. Allow enough slack to easily attach the wires to the terminal block.

NOTE: Do not install the conduit without a squeeze connector.

A Ground strap is supplied in the conversion pack.

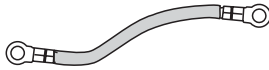

*ground strap.*

Fit the Ground strap to the ground and center terminal of the connector block - see the figure.

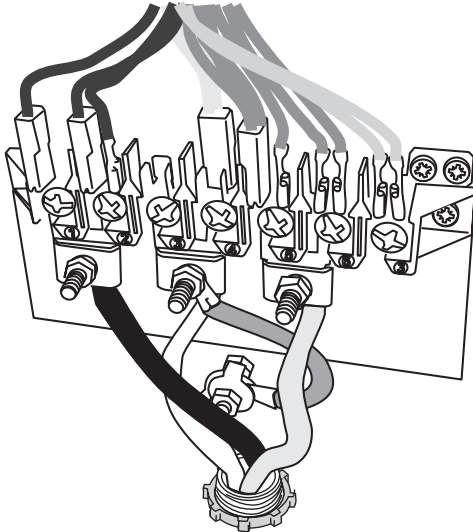

The neutral or ground wire of the power cord must be connected to the neutral terminal located in the center of the connector block. The power leads must be connected to the outside terminals.

NOTE: Make sure the wires are completely inserted into the terminals and secure connections are made.

Secure the squeeze connector in place in the bracket by tightening the squeeze connector screws.

### Seal the Openings

Seal any openings in the wall behind the range and in the floor under the range when hookups are completed.

### When all Connections are Completed

MAKE SURE THE FLOW OF COMBUSTION AND VENTILATION AIR TO THE RANGE IS UNOBSTRUCTED.

Read all instructions before installing or using this appliance.

## Installation Instructions

Save these instructions for future reference.

### Assemble the range

#### Fit the Door Handles

Remove the 4mm Hex headed screws from the doors with the hexagon key tool. Use the screws to fit the door handles.

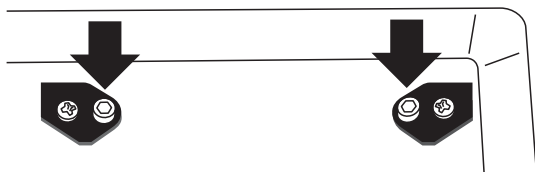

The handles should be above the fixings.

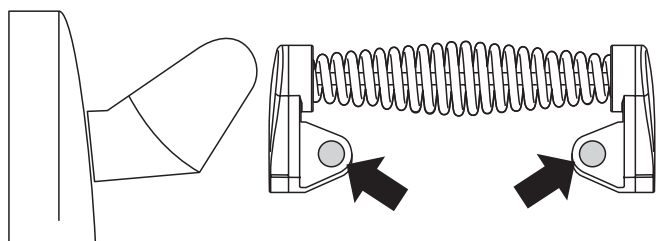

Fit the plastic blanking plugs to the fixing holes.

#### Fit the Handrail



Remove the 4mm Hex headed screws from the top corners of the fascia.

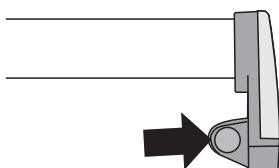

Fix the front handrail in position. Fit the plastic blanking plugs to the fixing holes.

### Fitting the rear spacer

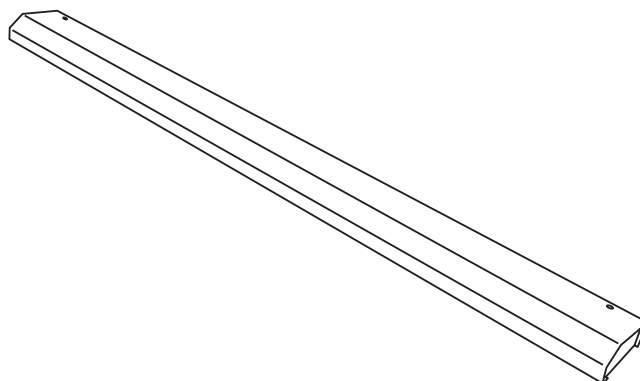

*Rear spacer.*

Fix the splash to the flue grill with the two screws from below and then fit the two end caps.

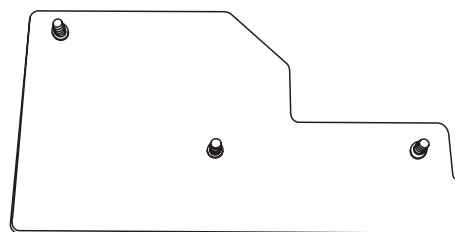

*End cap*

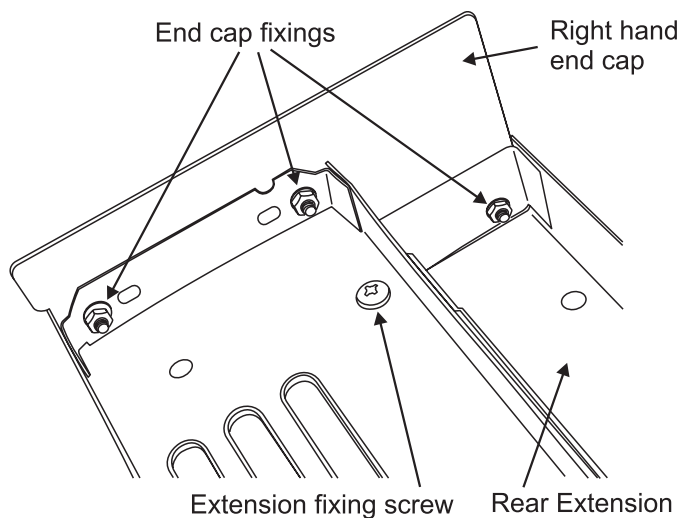

They are held in place by three fixing nuts on the inside face.

Refit the complete assembly of the flue grille rear extension and splash to the range using the two screws.

Read all instructions before installing or using this appliance.

## Installation Instructions

Save these instructions for future reference.

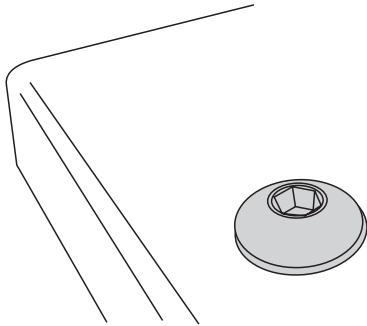

Remove the two fixing screws (3mm hexagonal socket head) and nuts that pass through the top of the rear flue grille.

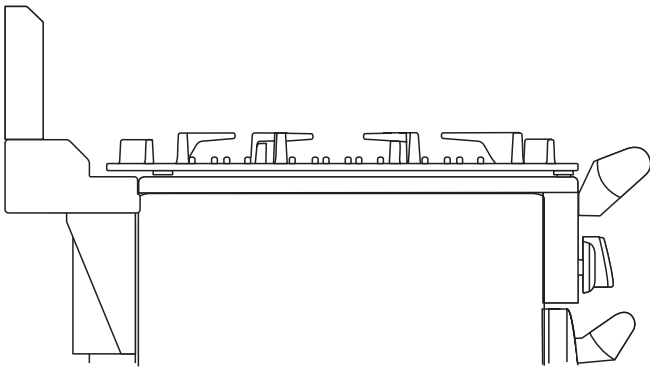

### Assemble the Grates

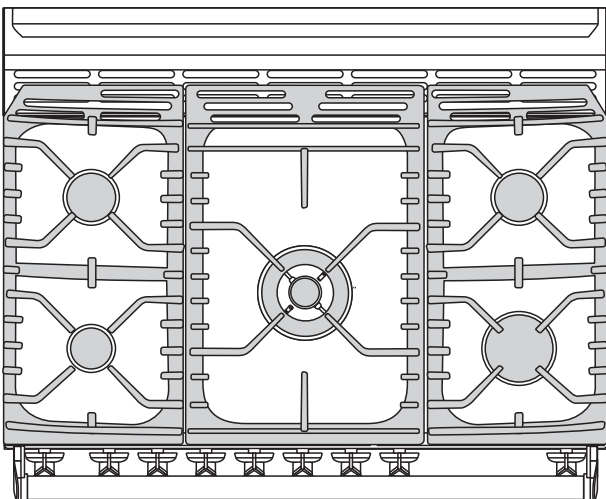

Each grate is different. Make sure that the grates are in the correct position and sitting down.

### Fit the plinth

The plinth is held in place by magnetic catches. Fit it in place.

Read all instructions before installing or using this appliance.

## Installation Instructions

Save these instructions for future reference.

### Range operational checks

#### Oven check

Set the clock to the time of day - the ovens will not work if the clock is not set.

When the clock is first connected the display will flash ( 0.00 ) and ( 0:00 ) alternately.

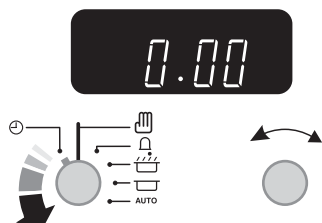

To set the clock to read the time of day turn and hold the Setting knob to the clock symbol (⌚) and at the same time turn the Adjusting knob left or right until the clock shows the time of day. This is a 12 hour clock. Let go of the Setting knob and it will spring back to the vertical (↑) oven manual setting.

Turn on the oven and check that the oven fan starts to turn and that the oven starts to heat up. Turn off the oven.

#### Broiler

Open the broiler compartment door. Turn on the broiler control and check that the broiler heats up.

#### Oven Light

Press the Main oven light switch and check that the light is working.

Note. The oven light bulb is not included in the guarantee

#### Check Ignition of Cooktop Burners

Operation of all cooktop burners should be checked after the range and gas supply lines have been carefully checked for leaks.

Check each burner in turn. There is a flame safety device that stops the flow of gas to the burner if the flame goes out. There is also a spark ignition system that works when the knob is pressed in.

For each burner, push in and turn a knob to the ( HI ) lighting position.

The igniter should spark and light the gas. Keep holding the knob pressed in to let the gas through to the burner for few seconds.

If, when you let go of the control knob, the burner goes out, the safety device has not held in. Turn the control to the off position and wait one minute, then try again this time holding in the control knob for slightly longer.

#### Quality of Flames

On Natural Gas the burners flames should be a blueish color with, at most, a slight yellowish fringe.

On Propane gas the flames may be "softer". The cooktop burner flames may have a slight yellowish tip.

If the flame burns with a long white tip you should call for service.

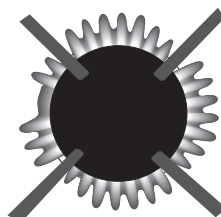

Normal flame appearance

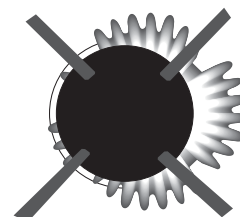

Burner not fitted correctly

MAKE SURE THE FLOW OF COMBUSTION AND VENTILATION AIR TO THE RANGE IS UNOBSTRUCTED.

MAKE SURE ALL CONTROLS ARE LEFT IN THE OFF POSITION.

#### Customer care

Please complete your details in the inside cover of this Guide. Then replace this Installation Guide back in the Customer Care Pack in the correct position. Please inform the user how to operate the range and hand over the Customer Care Pack.

Thank you.

**SERVICING - WARNING**

Disconnect from electricity and gas before servicing. Check appliance is safe when you have finished.

## Conversion to an other gas

This appliance is supplied set for Natural gas. A conversion kit for Propane gas is supplied with the range.

If the appliance is to be converted this must be done before installation. The conversion must be performed by a qualified LP gas installer. After conversion the installation must comply with the relevant regulations and also the local electricity supply company requirements. Read the instructions before converting this appliance.

Failure to convert the appliance correctly could invalidate any warranty or liability claims and lead to prosecution.

This instruction must be used in conjunction with the rest of the appliance instruction, in particular for information on Standards, range positioning, connection hose suitability etc.

When servicing or replacing gas-carrying components disconnect from gas before commencing operation and check appliance is gas sound after completion.

Do not use re-conditioned or unauthorised gas controls.

### Orifices

Standard burner

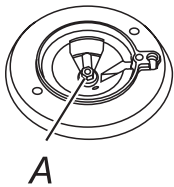

Wok burner

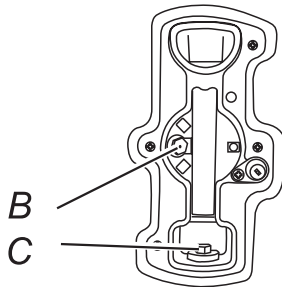

A orifice, B internal injector, C external injector  
Remove burner caps and heads. Remove old orifices, save the orifices removed from the appliance for future use. Fit new orifices. Reassemble in reverse order.

Orifices	Natural Gas		Propane Gas	
Wok burner	internal	110	internal	71
	external	166	external	93
Large Burner		170		106
Medium Burners		150		84
Small Burner		107		61

### Valve adjustment

Pull off all the control knobs. If the hand rail has been fitted remove it - remove the plastic blanking plugs and remove the 2 end bracket fixing screws.

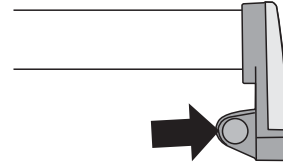

Remove the 2 cross headed screws that were hidden by the hand rail end brackets.

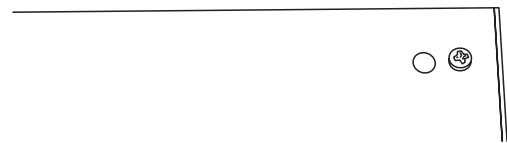

Open the oven door & or broiler door and remove the fixing screws underneath the control panel.

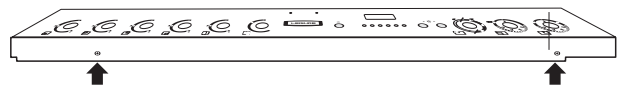

Lower control panel clear.

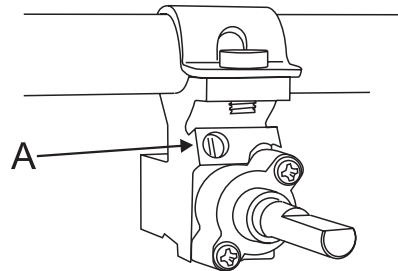

A valve bypass screw

Take out the bypass screw and replace with the correct new screw on each gas control. Save the screws removed from the appliance for future use.

### Valve Bypass screws

	Natural Gas	Propane Gas
Wok burner	82	49
Large Burner	70	38
Medium Burners	53	31
Small Burner	43	22

## SERVICING - WARNING

Disconnect from electricity and gas before servicing. Check appliance is safe when you have finished.

### Gas Regulator

Remove the flue grille and splash assembly from the rear of the range by removing the two fixing screws.

The regulator is now accessible. Unscrew the brass top of the regulator.

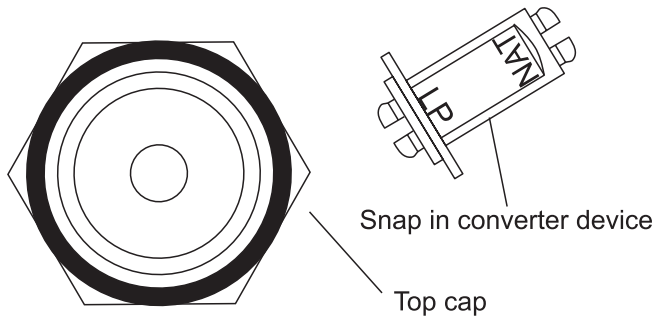

In the base of the brass top is a plastic snap in converter device.

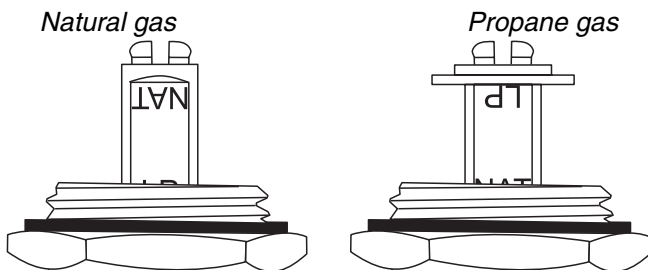

To convert the regulator snap the device out of the top and refit the other way up. The snap in converter device is marked to show which gas it is set for. Make sure the device is secure in the top cap and refit the cap to the regulator.

### Stick on label

Stick the appropriate label on to the data badge to indicate the gas the appliance is now set for. The data badge is located under the Main oven. Remove the plinth by pulling forward (it is held in place by magnetic catches) and pull forward on the sheet metal tag under the center of the oven to swing out the badge plate.

### Pressure Testing

Connect the appliance to the gas supply. Check the appliance is gas sound.

The gas pressure can be measured at one of the central cooktop burner orifices. Lift off a burner head. Fit the pressure gauge to the orifice. Turn on the cooktop burner and turn on and light one of the other burners.

Reassemble burner top, making sure it is reassembled in the correct way on the burner body.

### Refit the Flue grille assembly

**Check the appliance is gas sound.**

**Check operation of all the burners.**

Read all instructions before installing or using this appliance.

## Installation Instructions

Save these instructions for future reference.

### Schematic diagram of the Range

**Caution:** Label all wires prior to disconnection when servicing controls. Wiring errors can cause improper and dangerous operation. Verify proper operation after servicing.

Code	Description
BRE	Broiler elements
BSB	Broiler switch block
BTC	Broiler controller
CFM	Cooling fan motor
IGS	Ignition switches
ISG	Ignition spark generator
LBE	Left hand bottom element
LFE	Left hand fan element
LTI	Left hand top inner element
LTO	Left hand top outer element
LOS	Left hand oven switch block
NLI	Neon indicator light
OFM	Oven fan motor
OLS	Oven light switch
OTL	Left hand oven thermostat
OTR	Right hand oven thermostat
OVL	Oven light bulb
ROE	Right hand oven element
RSB	Right hand oven switch block
TCK	Timer clock
TCO	Thermal cut out

Code	Color
BK	Black
BL	Blue
BR	Brown
GY	Grey
O	Orange
R	Red
V	Violet
W	White
Y	Yellow



Read all instructions before installing or using this appliance.

## Installation Instructions

Save these instructions for future reference.

### Technical Data

---

**This range is supplied set for Natural gas.**

**A conversion kit from NG to LP gas is included.**

INSTALLER: Please leave these instructions with the User.

DATA BADGE LOCATION: Under the Main oven. Remove the plinth by pulling forward (it is held in place by magnetic catches) and pull forward on the sheet metal tag under the center of the oven to swing out the badge plate.

Country of Destination: USA/Canada

Gas		Electric
Natural Gas	4.0" W.C (10 mbar)	240V 60Hz
Propane	10.0" W.C (25 mbar)	

(See appliance data badge for test pressures)

### Dimensions

Overall height (splash not fitted)	minimum 35 <sup>3</sup> / <sub>8</sub> " (89.8 cm)	maximum 36 <sup>7</sup> / <sub>16</sub> " (92.5 cm)
Overall width	35 <sup>1</sup> / <sub>2</sub> " (90cm) See 'Positioning the Range'	
Overall depth with spacer	28 <sup>3</sup> / <sub>4</sub> " (73cm)	
Space for fixing	See 'Positioning the Range'	
Minimum space above cooktop	30" (76cm)	

### Connections

Gas :	Electric:
<sup>1</sup> / <sub>2</sub> " NPT at rear right-hand side	240 V 60 Hz

Read all instructions before installing or using this appliance.

## Installation Instructions

Save these instructions for future reference.

### Orifices

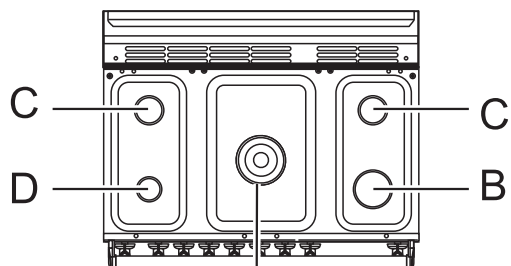

A

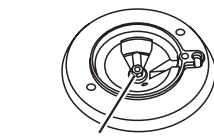
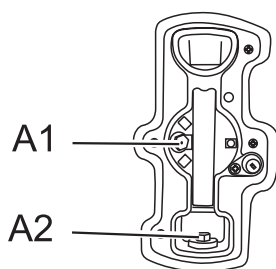
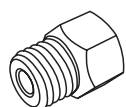

B, C, D

- A Wok burner
- B Large Burner
- C Medium Burners
- D Small Burner

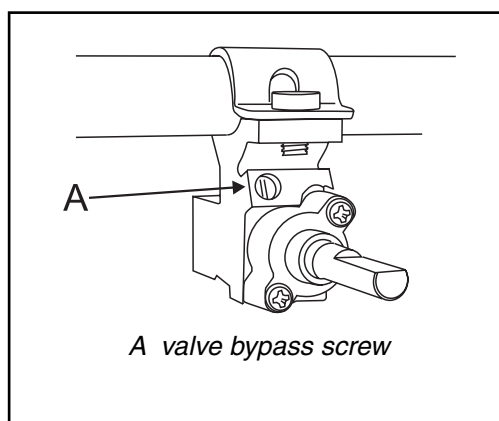

A valve bypass screw

### Ratings

	Natural Gas		Propane Gas	
	Orifice	Screw	Orifice	Screw
<b>Cooktop</b>				
Wok burner	15,000Btu/hr	internal 110 external 166	82	15,000Btu/hr internal 71 external 93
Large Burner	12,000Btu/hr	170	70	12,000Btu/hr 106
Medium Burners	9,200Btu/hr	150	53	8,000Btu/hr 84
Small Burner	5,000Btu/hr	107	43	4,200Btu/hr 61

Gas burner inputs based on Gross Calorific Value

### Ovens

#### Left hand Multifunction Oven

#### Right hand Fan Oven

Fan element	2.5kW	2.5kW
Top element	1.2kW	
Browning Element	1.15kW	
Bottom element	1.0kW	
<b>Broiler</b>	<b>2.3kW</b>	

**Maximum total electrical load at 240V 7.4kW\***

\*approximate total including oven lights, oven fan etc.







Aga Ranges  
110 Woodcrest Road  
Cherry Hill, NJ 08003 USA  
1.866.4AGA.4USA  
[www.aga-ranges.com](http://www.aga-ranges.com)  
Email [support@aga-ranges.com](mailto:support@aga-ranges.com)