

Convection Microwave Oven

MODEL MWC24

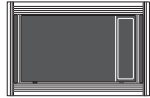

Model MWC24
(free-standing)



Model MWC24
(30" trim)

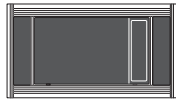

Model MWC24
(36" trim)

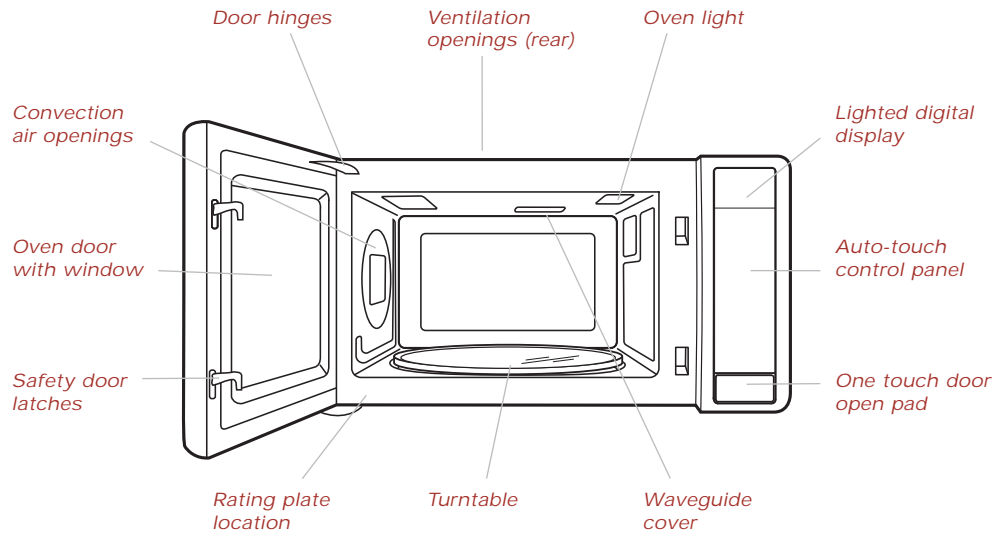

► The Wolf Model MWC24 24" (610) convection microwave oven can be used free-standing or with optional 30" (762) or 36" (914) trim, it can be built in to fit above a Wolf 30" (762) or 36" (914) single oven. Optional trim is available in classic, platinum or carbon stainless steel finish.

Taking the experience we've gained from our microwave ovens and combining that with the expertise of convection, Wolf has brought the best of both cooking technologies together in one unit.

This handsome unit comes with optional trim to mount the unit next to a 30" (762) or 36" (914) Wolf oven and finish off your cooking tower in a single look. The trim comes in three stainless steel looks—classic, platinum and carbon.

Aside from looking beautiful whether you use it in conjunction with an oven or not, the unit offers you all the performance you would expect from Wolf—a cooking company with a heritage of nearly 75 years in the kitchen.

Convection Microwave Oven

MODEL MWC24

FEATURES

- ▶ Built-in or free-standing convection microwave oven with 1.5 cu ft (43 L) capacity and 900 watts of power
- ▶ Optional 30" (762) or 36" (914) trim allows microwave to be built in to fit above a Wolf built-in oven
- ▶ Classic, platinum or carbon stainless steel trim finishes
- ▶ Sensor cooking
- ▶ Slow cook mode for up to four hours
- ▶ Easy to operate control panel and programmable power options
- ▶ Interactive display—99 minutes, 99 seconds
- ▶ Menu label and recipe guide
- ▶ Multi-language—English, French and Spanish
- ▶ Removable turntable and turntable support
- ▶ Oven door with window
- ▶ Multiple rack baking
- ▶ Safety door latches—oven will not operate unless the door is securely closed
- ▶ Oven light comes on when oven is operating or door is open
- ▶ Tight door seals with one touch door open pad
- ▶ Rear ventilation openings
- ▶ Two and five year residential warranty—exclusions apply, see warranty at the end of this guide

OVERALL DIMENSIONS ▼

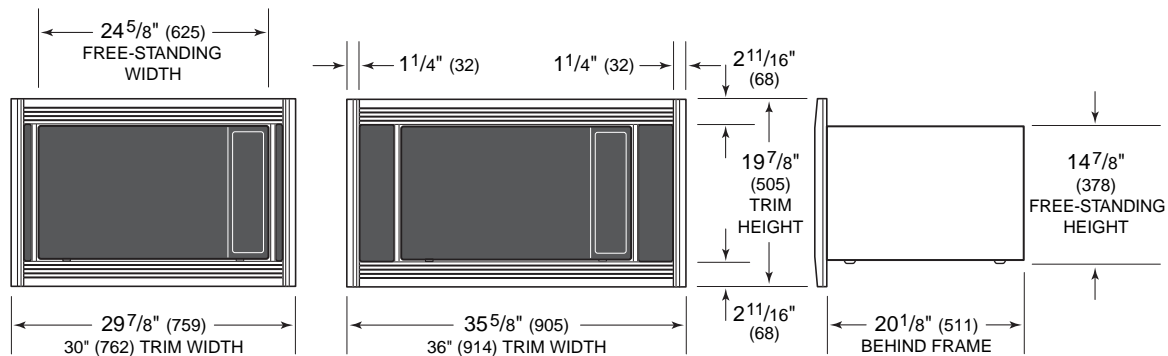

- ▶ Dimensions may vary by $\pm 1/8"$ (3).
- ▶ Dimensions in parentheses are in millimeters unless otherwise specified.

Convection Microwave Oven

MODEL MWC24



Model MWC24
(free-standing)

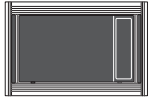

Model MWC24
(30" trim)



Model MWC24
(36" trim)

30" (762) TRIM OPTIONS ▼

| | |
|--------------------|-------------|
| Classic Stainless | MWCTRIM30/S |
| Platinum Stainless | MWCTRIM30/P |
| Carbon Stainless | MWCTRIM30/B |

Trim allows Model MWC24 to be built in to fit a 30" (762) wide space.

36" (914) TRIM OPTIONS ▼

| | |
|--------------------|-------------|
| Classic Stainless | MWCTRIM36/S |
| Platinum Stainless | MWCTRIM36/P |
| Carbon Stainless | MWCTRIM36/B |

Trim allows Model MWC24 to be built in to fit a 36" (914) wide space.

Optional trim kits are ordered and shipped as sales accessories.

SPECIFICATIONS ▼

| | |
|---|--|
| Free-Standing Microwave— | |
| Overall Width | 24 ⁵ / ₈ " (625) |
| Overall Height | 14 ⁷ / ₈ " (378) |
| Microwave with 30" (762) Trim— | |
| Overall Width | 29 ⁷ / ₈ " (759) |
| Overall Height | 19 ⁷ / ₈ " (505) |
| Microwave with 36" (914) Trim— | |
| Overall Width | 35 ⁵ / ₈ " (905) |
| Overall Height | 19 ⁷ / ₈ " (505) |
| Overall Depth | 20 ¹ / ₈ " (511) |
| Interior Capacity | 1.5 cu ft (43 L) |
| Interior Dimensions | 16 ¹ / ₈ " W x 9 ⁵ / ₈ " H x 16 ¹ / ₈ " D (410 x 244 x 410) |
| Microwave with 30" (762) Trim— | |
| Recommended Cabinet Width | 33" (838) |
| Minimum Cabinet Width | 30" (762) |
| Microwave with 36" (914) Trim— | |
| Recommended Cabinet Width | 39" (991) |
| Minimum Cabinet Width | 36" (914) |
| Trim Overlaps | ⁵ / ₁₆ " (8) top, ¹³ / ₁₆ " (21) bottom, 1 ³ / ₁₆ " (30) sides |
| Power | 900 W |
| Total Power Requirement (with convection) | 1.6 kw |
| Electrical Supply Requirements | 120 V AC, 60 Hz 15 amp dedicated circuit |
| Power Cord | 3 ¹ / ₂ ft (1.1 m) power cord with 3-prong grounded plug |
| Shipping Weight | 68 lbs (31 kg) |

► Specifications are subject to change without notice.

► Dimensions in parentheses are in millimeters unless otherwise specified.

Convection Microwave Oven

INSTALLATION (30" TRIM)

INSTALLATION ABOVE 30" (762) SINGLE OVEN

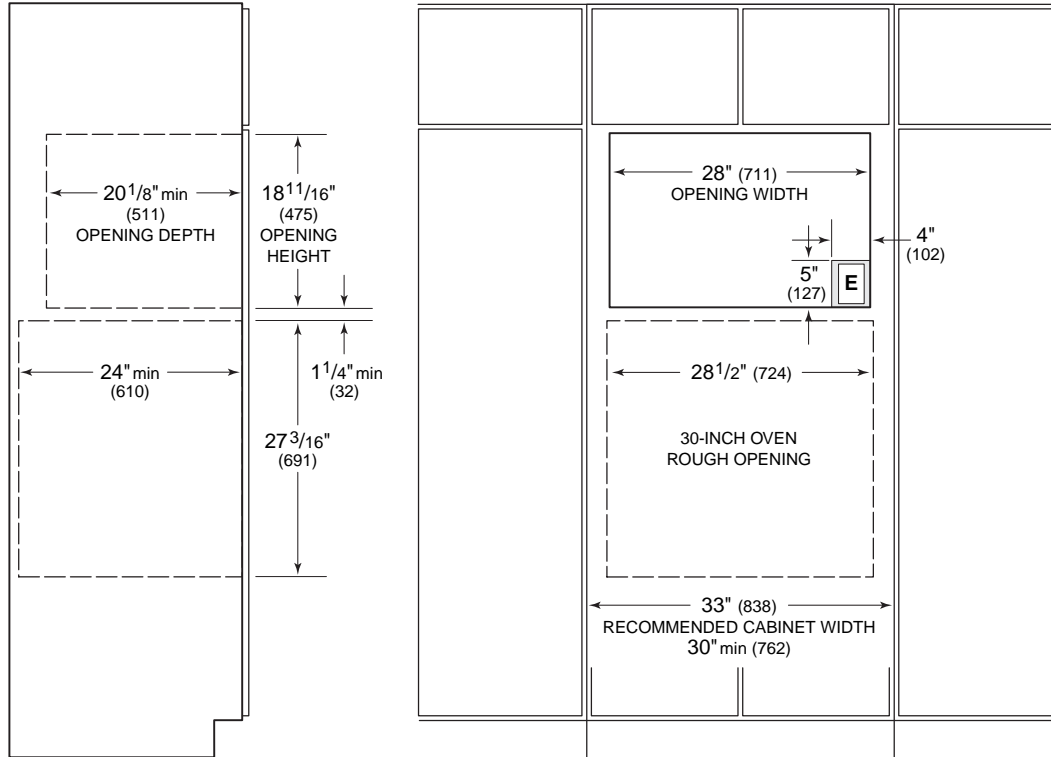

NOTE: At installation, wood cleats must be added to the opening for the microwave trim.

UNDERCOUNTER INSTALLATION

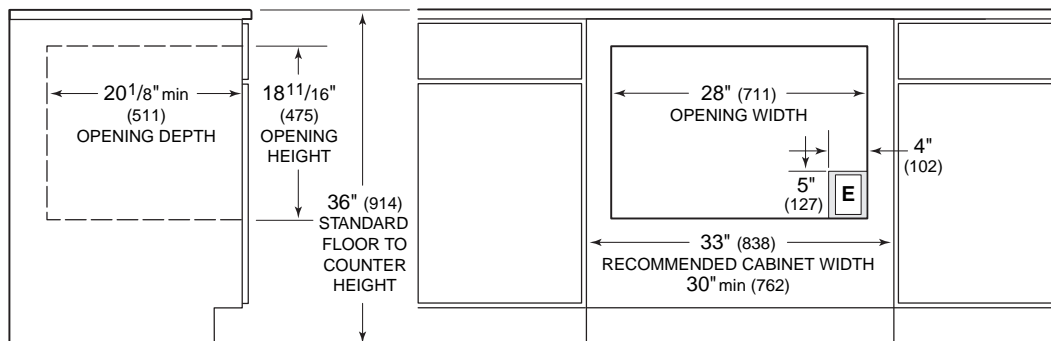

NOTE: At installation, wood cleats must be added to the opening for the microwave trim.

- ▶ Dimensions may vary by $\pm 1/8$ " (3).
- ▶ Dimensions in parentheses are in millimeters unless otherwise specified.
- ▶ Dimensions shown in the illustrations are for installation of the microwave oven with 30" (762) trim.

Convection Microwave Oven

INSTALLATION (30" TRIM)

INSTALLATION NOTES

- ▶ Refer to the illustrations and specifications for overall dimensions, rough openings and installation specifics.
 - ▶ The Wolf convection microwave oven can be used free-standing or with optional 30" (762) trim, can be built in to fit above a Wolf 30" (762) single oven. The base platform must be able to support 125 lbs (57 kg).
- IMPORTANT NOTE:** In all instances, where the microwave oven is built in, you must use one of Wolf's trim kits to ensure proper ventilation.
- ▶ The trim kit for the Wolf convection microwave oven will overlap cabinetry stiles and rails on all four sides. The trim overlaps $\frac{5}{16}$ " (8) on the top, $\frac{13}{16}$ " (21) on the bottom and $1\frac{3}{16}$ " (30) on each side.
 - ▶ At installation, wood cleats (not included) must be added to the microwave opening for the 30" (762) trim. Refer to the installation instructions provided with the trim kit for detailed specifications. These instructions can also be found on the Wolf website at wolfappliance.com.
 - ▶ When using the Wolf microwave oven as a free-standing unit, allow 2" (51) of airflow space on top, rear and both sides. A minimum $20\frac{1}{8}$ " (511) cabinet depth is required.

- ▶ The Wolf convection microwave oven requires a separate, grounded 120 V AC, 60 Hz power supply. The service should have its own 15 amp circuit breaker and a grounded 3-prong receptacle should be located within the reach of the $3\frac{1}{2}$ ' (1.1 m) power cord. Locate electrical within the shaded area shown in the installation illustration.

IMPORTANT NOTE: A ground fault circuit interrupter (GFCI) is not recommended and may cause interruption of operation.

- ▶ The Wolf convection microwave oven with 30" (762) trim may be installed in combination with a 30" (762) single oven and/or warming drawer. Refer to the **General Applications** section for additional installation specifications.
- ▶ You must follow all National Electrical Code regulations. In addition, be aware of local codes and ordinances when installing your service.
- ▶ Refer to the installation instructions shipped with each Wolf product for detailed specifications.

DIMENSIONS

| | |
|-------------------------------|---------------------------|
| Rough Opening Width | 28" (711) |
| Rough Opening Height | $18\frac{11}{16}$ " (475) |
| Rough Opening Depth (minimum) | $20\frac{1}{8}$ " (511) |
| Recommended Cabinet Width | 33" (838) |
| Minimum Cabinet Width | 30" (762) |
| Location of Electrical | Within shaded area |

- ▶ See *Installation Instructions shipped with unit for detailed specifications.*
- ▶ *Dimensions in parentheses are in millimeters unless otherwise specified.*

Convection Microwave Oven

INSTALLATION (36" TRIM)

INSTALLATION ABOVE 36" (914) SINGLE OVEN

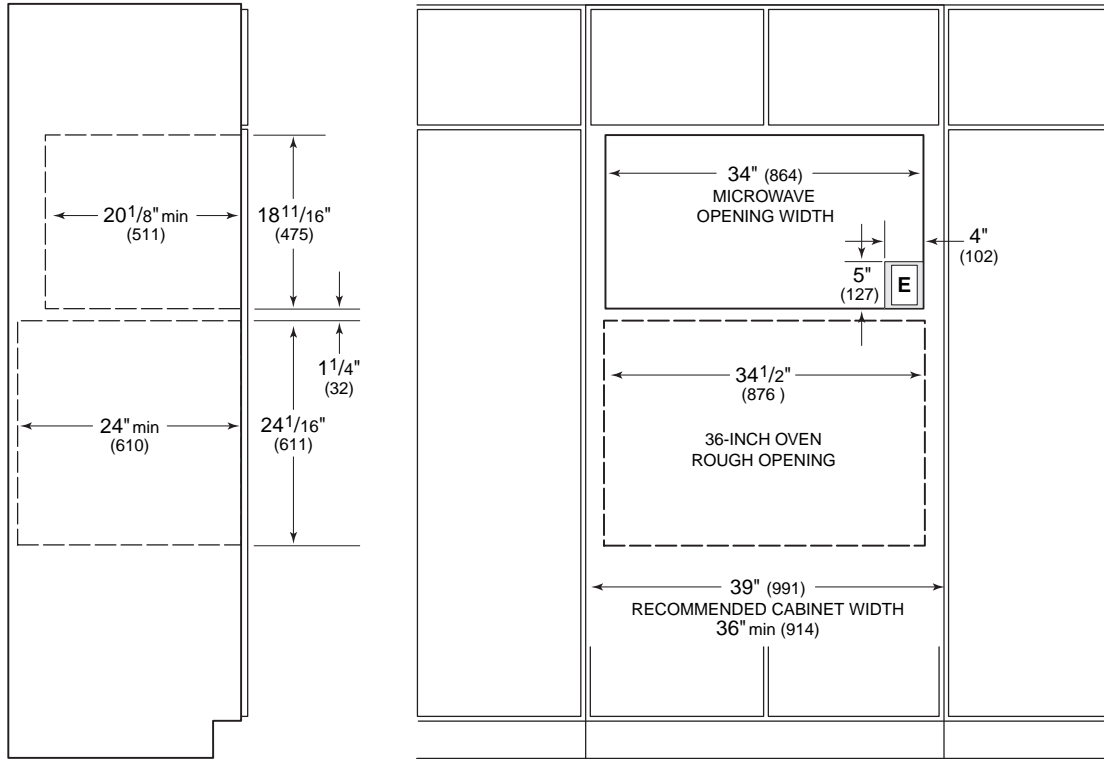

NOTE: At installation, wood cleats must be added to the opening for the microwave trim.

UNDERCOUNTER INSTALLATION

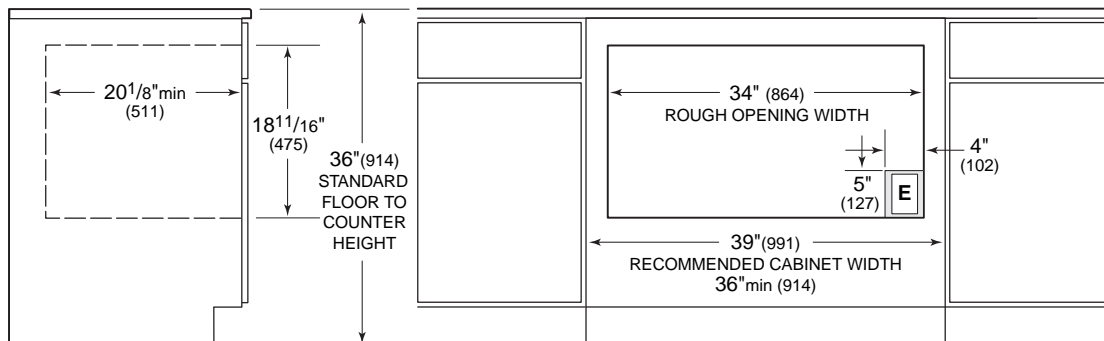

NOTE: At installation, wood cleats must be added to the opening for the microwave trim.

- ▶ Dimensions may vary by $\pm 1/8$ " (3).
- ▶ Dimensions in parentheses are in millimeters unless otherwise specified.
- ▶ Dimensions shown in the illustrations are for installation of the microwave oven with 36" (914) trim.

Convection Microwave Oven

INSTALLATION (36" TRIM)

INSTALLATION NOTES

- ▶ Refer to the illustrations and specifications for overall dimensions, rough openings and installation specifics.
 - ▶ The Wolf convection microwave oven can be used free-standing or with optional 36" (914) trim, can be built in to fit above a Wolf 36" (914) single oven. The base platform must be able to support 125 lbs (57 kg).
- IMPORTANT NOTE:** In all instances, where the microwave oven is built in, you must use one of Wolf's trim kits to ensure proper ventilation.
- ▶ The trim kit for the Wolf convection microwave oven will overlap cabinetry stiles and rails on all four sides. The trim overlaps $\frac{5}{16}$ " (8) on the top, $\frac{13}{16}$ " (21) on the bottom and $1\frac{3}{16}$ " (30) on each side.
 - ▶ At installation, wood cleats (not included) must be added to the microwave opening for the 36" (914) trim. Refer to the installation instructions provided with the trim kit for detailed specifications. These instructions can also be found on the Wolf website at wolfappliance.com.
 - ▶ When using the Wolf microwave oven as a free-standing unit, allow 2" (51) of airflow space on top, rear and both sides. A minimum $20\frac{1}{8}$ " (511) cabinet depth is required.

- ▶ The Wolf convection microwave oven requires a separate, grounded 120 V AC, 60 Hz power supply. The service should have its own 15 amp circuit breaker and a grounded 3-prong receptacle should be located within the reach of the 3 $\frac{1}{2}$ ' (1.1 m) power cord. Locate electrical within the shaded area shown in the Installation illustration.

IMPORTANT NOTE: A ground fault circuit interrupter (GFCI) is not recommended and may cause interruption of operation.

- ▶ The Wolf convection microwave oven with 36" (914) trim may be installed in combination with a 36" (914) single oven and/or warming drawer with integrated drawer front. Refer to the **General Applications** section for additional installation specifications.
- ▶ You must follow all National Electrical Code regulations. In addition, be aware of local codes and ordinances when installing your service.
- ▶ Refer to the installation instructions shipped with each Wolf product for detailed specifications.

DIMENSIONS ▼

| | |
|-------------------------------|----------------------------|
| Rough Opening Width | 34" (864) |
| Rough Opening Height | 18 $\frac{11}{16}$ " (475) |
| Rough Opening Depth (minimum) | 20 $\frac{1}{8}$ " (511) |
| Recommended Cabinet Width | 39" (991) |
| Minimum Cabinet Width | 36" (914) |
| Location of Electrical | Within shaded area |

- ▶ See *Installation Instructions shipped with unit for detailed specifications.*
- ▶ *Dimensions in parentheses are in millimeters unless otherwise specified.*